

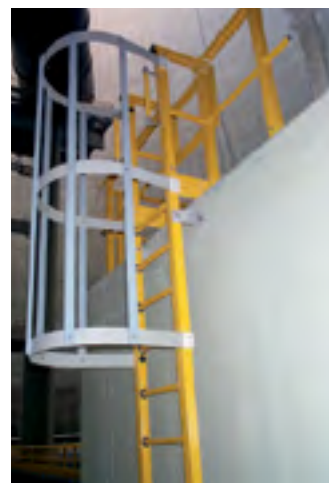

GRP Manual

lichtgitter
— GFK

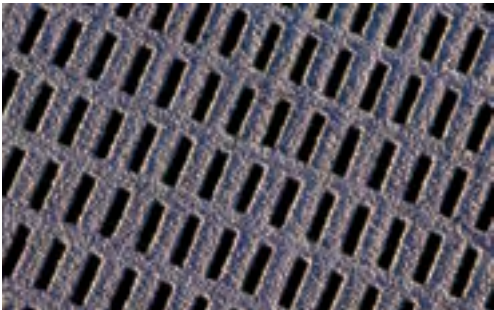
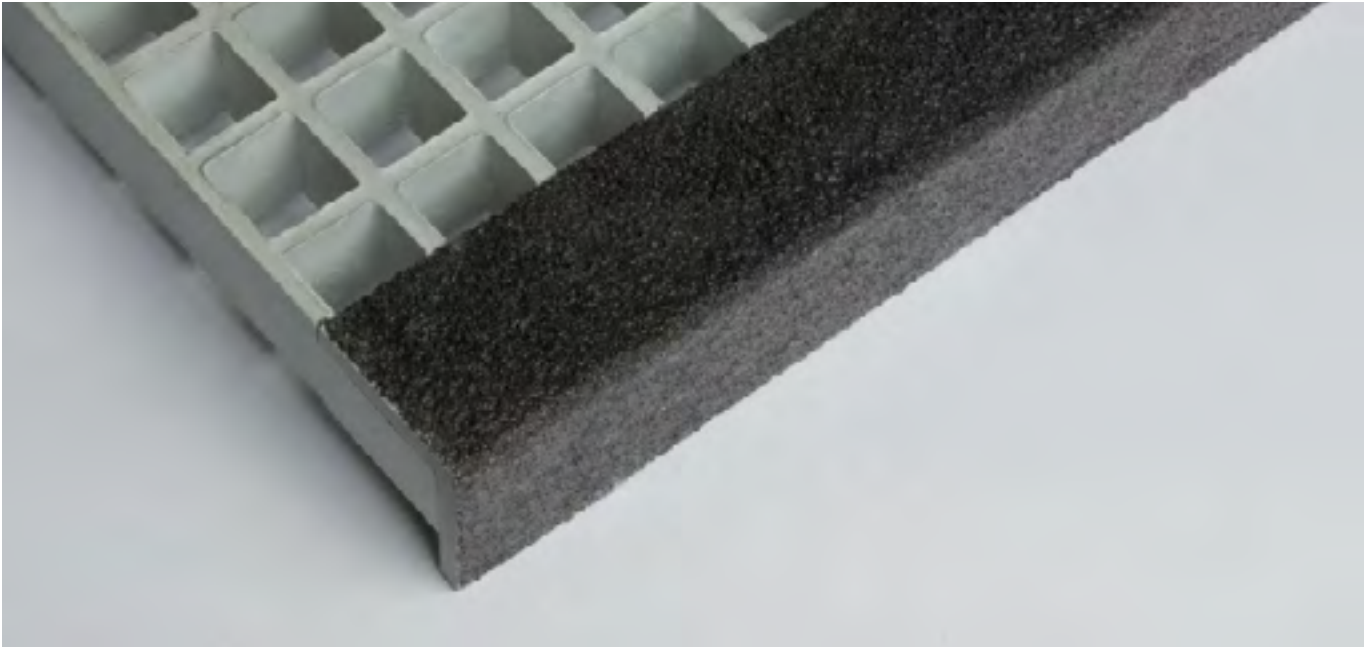

The Company.....	4	Positioning mounts	43 – 45
Service, advertising.....	5	Applications of GRP structures.....	46 – 49
Quality demands standards.....	6	Pultrusion method & material characteristics.....	50 – 51
Certificates.....	7	GRP standard profiles.....	52 – 53
Technical terms.....	8 – 9	Handrails.....	54 – 57
Production and quality control.....	10	Staircases.....	58 – 59
Sample applications.....	11 – 13	Platforms/Walkways.....	60 – 61
GRP moulded gratings.....	14 – 15	Ladders/Vertical ladders.....	62 – 63
GRP-K gratings - moulded with a concave surface.....	16 – 19	Grating tolerances.....	64
GRP-G gratings - moulded with a smooth surface.....	20 – 25	GRP grating pricing.....	65
GRP-S gratings – moulded to support heavy loads.....	26 – 31	Handling guidelines.....	66
Stairtreads and staircases.....	32 – 33	Safety information sheet.....	67
Surfaces.....	34 – 35		
Special applications.....	36		
Chemical resistance.....	37		
Anti-slip characteristics.....	38		
Flammability.....	39		
Fixings.....	40 – 41		
GRP grating accessories	42		

Continuously improving our services and quality, developing innovative manufacturing techniques and keeping a careful eye on our market – these are some of the qualities that have made Lichtgitter one of Europe's leading manufacturers of grating flooring.

Both our manufacturing methods which have been patented many times and our specialised machinery are finely tuned to optimise production.

We manufacture gratings capable of bearing both normal and heavy loads with our advanced production technology. Our catalogue includes gratings and sheet metal profile gratings made from steel, stainless steel and aluminium, e.g. gratings designed for both vehicular and pedestrian use, ceiling gratings, anti-glare panels and staircases - including spiral staircases. We always accept orders for special or one-off products made of gratings and sheet metal profile gratings as a welcome test of our technical know-how.

Our German grating production plants are located in Stadtlohn, Westphalia, Sulz am Neckar and Casekow OT Blumberg/Uckermark.

The steel products manufactured in our German production plants are surface treated in the Group's own galvanising plants.

We founded affiliated companies to act as a link between local companies and Lichtgitter to achieve as a significant local presence as possible and to integrate our products into the grating market in Europe and beyond. This has allowed us to develop our sales and production networks on a global scale.

Lichtgitter operates numerous branches and service centres both in and outside of Europe to build up our network of contacts and offer advice to our customers. This allows us to both keep our delivery times to a minimum and provide well-informed consultations about how our products can be applied.

Lichtgitter now intends to turn its focus towards developing ground-breaking solutions to the problems faced in the manufacturing and application of grating flooring.

If you want to see progress and innovation, you need a vision and a sense of responsibility. Lichtgitter and its staff are committed to meeting these high standards.

The Lichtgitter Group has been involved in glass-reinforced plastic (GRP) products since the early 90's.

Under the motto "the one-stop shop", Lichtgitter built up its sales around a wide range of GRP products, cementing its position as one of the leading manufacturers and suppliers of flooring in Europe.

Our many years of positive experience in the use of GRP products in the industrial sector as well as the public and private sectors have made us well aware that GRP material holds distinct advantages in a variety of locations and situations.

Lichtgitter has included GRP products in its catalogue to answer the shifting demands of the national and international markets.

In addition to our established range of GRP flooring designs, we have also added GRP construction profiles and related application possibilities to our catalogue.

The versatility of GRP products in nearly all areas of business makes this development interesting.

The sky is the limit for the use of GRP materials in construction - whether for substructures, handrail systems, vertical ladders or complete platforms.

Our experienced and competent staff enjoy developing tailored solutions for customer requests, creating a steady stream of new application areas for GRP products.



Providing competent product and building advice with a great deal of technical know-how and expertise comes naturally to us. We take great pleasure in taking on tailored requests and developing new application solutions to meet demands.

- our well-trained sales force, technicians and dealers provide personalised consultations
- we provide technical advice when dimensioning and selecting GRP gratings and assistance with the choice of fixings
- we produce product brochures (see examples)
- we draw up bids quickly in accordance with project-specific requirements as well as applicable standards and regulations
- we can provide an estimate upon customer request – we will also gladly submit a quotation
- we draw up installation plans with CAD software
- we plan, draft and develop GRP structures in line with structural requirements
- we carry out structural analyses in line with our service palette
- we draw up 3D construction diagrams/views if required
- we work together with national/international trade associations and commissions to finalise standards and guidelines
- we install GRP gratings and structures on request

We offer a range of individualised product brochures in both printed and electronic format:

Example 1:
Lichtgitter GRP grating
GRP-K 638-38-6

Manufactured from high-quality isophthalic resin and reinforced with glass fibre.

Colour: grey, similar to RAL 7035
Surface: concave
Grating height: 38 mm
Land width: 6 to 7 mm
Mesh spacing: 38 x 38 mm
Mesh width: 31 x 31 mm

Anti-slip quality class: R 13 according to BGR 181

Flammability rating: flame resistant Bfl-s1

Loading and design in accordance with DIN 24537-3

Concentrated load: 1.5 kN
Load cube: 200 x 200 mm
Max. span in length: 700 mm
Deflection: max. 4 mm

Each grating is to be secured against being lifted or moved at a minimum of four corners.

Example 2:
Lichtgitter GRP handrails

Handrails made from GRP profiles reinforced with glass fibre, manufactured from high-quality isophthalic resin. The GRP handrails must be capable of bearing a horizontal load of 500 N/m and conform to DIN EN ISO 14122-3.

GRP handrails are composed of:

- Posts made out of square tubes: 60 x 60 x 5 mm
- Handrail: ergonomically formed
- 2 knee rails: pipe 40 mm
- Toe plate: 100 mm high
- Post feet complies with structural requirements for plugging onto concrete, stainless steel .
- All cut edges are to be permanently sealed
- Hollow profiles supplied with drainage holes
- All joints and connecting materials made from stainless steel .

Our years of experience in handling and machining GRP materials has made us well aware of the quality of the material. Lichtgitter played an influential role in drawing up DIN 24531-3 and DIN 24537-3. In August 2007, section 3 (plastic gratings) was added to the DIN 24531 and 24537 standards series and approved by the German Institute for Standardisation. The newly approved standards were the first guidelines in existence for the structural design and dimensioning of plastic gratings and stairtreads.

A fundamental component of DIN 24537-3 for structural design is a minimum initial safety factor of 3.0 against fracture and a deterioration factor of at least 1.3 during deviation. These values must be adapted according to the duration of exposure, media impact and ambient temperature.

The results

- High quality products
- Problem-solving know-how
- Handling major projects from the bidding phase through to installation
- Handling architecturally ambitious projects
- Our own testing facilities used for structural validation
- On-going quality control

Positive and reliable experience with the quality of our products is the deciding factor for our customers. We adhere to all applicable standards and regulations to guarantee this quality.

We supply our products whilst constantly adhering to the following standards and regulations:

DIN 24531-3
Gratings used as stairtreads – part 3: plastic gratings
Produced by: Mechanical Engineering Standards Committee for German Institute of Standardisation

DIN 24537-3
Gratings used as floor coverings – part 3: plastic gratings

DIN EN ISO 14122-1
Safety of machines, fixed access to machinery, choice of fixed means of access between two levels

DIN EN ISO 14122-2
Safety of machines, fixed access to machinery, working platforms and walkways

DIN EN ISO 14122-3
Safety of machines, fixed access to machinery, stairs, stepladders and handrails

DIN EN ISO 14122-4
Safety of machines, permanent means of access to machinery, fixed ladders

DIN EN 13706-1
Reinforced plastic composites – specification for pultruded profiles – part 1: code

DIN EN 13706-2
Reinforced plastic composites – specification for pultruded profiles – part 2: testing procedures and general requirements

DIN EN ISO 178
Plastics - regulation of flexural properties

DIN EN ISO 472
Plastics – technical vocabulary

DIN EN ISO 1172
Textile-glass-reinforced plastics – prepregs, moulding compounds and laminates – regulation of the textile-glass and mineral-filler content, calcinations methods

BGI 588
Instruction sheet for metal grating (previously ZH1/196)

BGR 181
Instruction sheet for flooring in working areas with skid risk (produced by Hauptverband der Gewerblichen Berufsgenossenschaften, BGZ "Structural Installations" technical committee).

RAL GZ 638
Gratings – quality assurance

AGI Worksheet H 10
Industrial gratings (produced by: Arbeitsgemeinschaft Industriebau e.V.).

Test certificates from the BIA for Lichtgitter anti-slip GRP floor coverings compliance with BGR 181.



Flammability classification testing conducted by North Rhine-Westphalia material testing office, of Technology and Innovation and TNO Environment and Geosciences

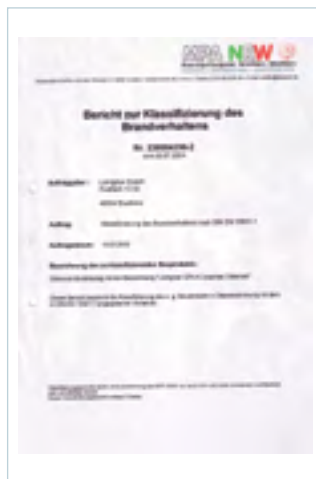

Verifiable structural analyses



Other certificates from the Technical Inspection Authority, RWTH Aachen and Verwaltungsgemeinschaft Maschinenbau- und Metall-Berufsgenossenschaft



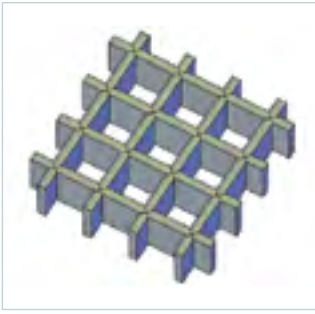

Supporting rods/crossbars
Moulded GRP gratings are constructed with supporting rods and crossbars of the same height. Only close-meshed GRP gratings have a different main mesh structure to the basic mesh structure (see panel dimensions detail page 17).

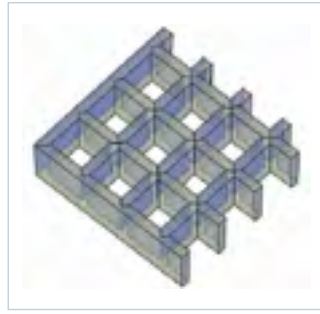

Open edges
GRP gratings whose external dimensions deviate from production dimensions might not have closed edges. Open edges are not included. The cut edges should be permanently sealed.

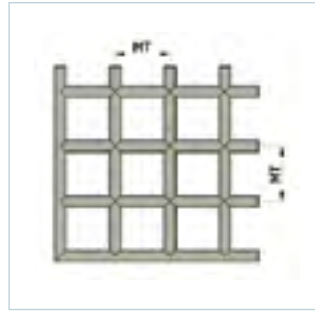

Mesh spacing
The distance from one axis to the other axis of supporting rods/crossbars.

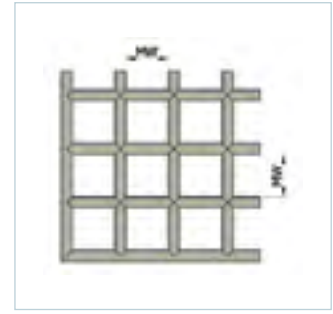

Mesh width
The clearance between supporting rods/crossbars.



Recess areas
Recess areas are necessary in the contact area if it is necessary to be on the same level as the neighbouring floor covering. Individual structural analyses should be carried out.

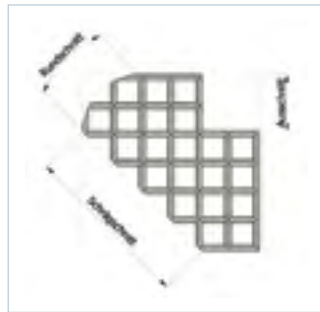

Cut-outs
Cut-outs are straight, diagonal and round cuts which deviate from the smallest possible surrounding rectangle or square. In contrast to steel gratings, these are not re-incorporated in accordance with DIN 24537-3.

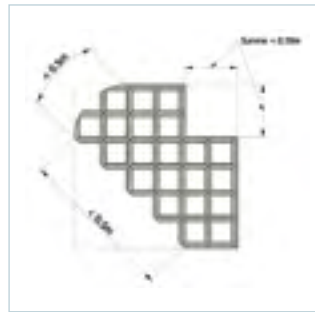

Small cuts
Small cuts are straight, diagonal and round cuts which are smaller than 0.5 running metre. These are calculated as allowances.



Toe plate
Flat material screwed onto the grating after construction which protrudes from the grating edge. It must be at least 100 mm higher than the grating surface.



Span
The span is the clearance between two supports.

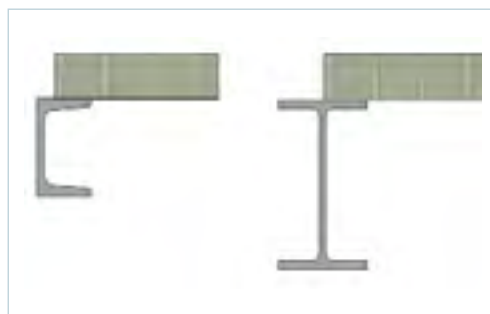

Substructure
A substructure is a structural component which a grating can be laid on.

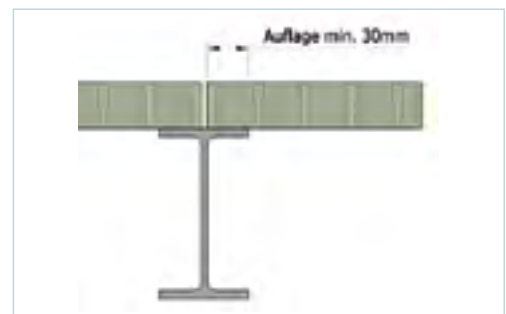

Support
The planned length of any support must be at least 30 mm. When in use, the support may not measure less than 25 mm. Deviations are permissible if structural measures ensure that the grating will not be displaced in the support direction.

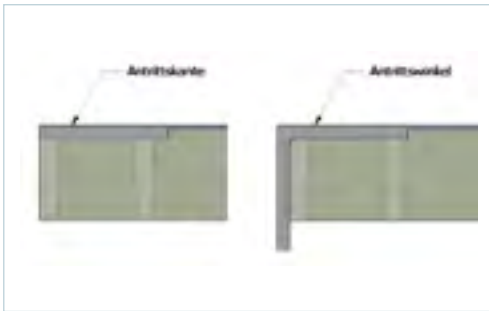

Black sanded solid nosing / nosing angle
We supply a solid black sanded toe plate in the entrance area to ensure that our stairtread gratings and platforms comply with DIN 24531-3. These can be constructed in the form of flat material or an angle depending upon structural requirements.

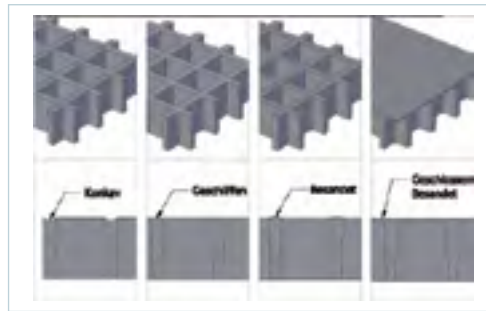

Surface/anti-slip
GRP gratings can be produced with a variety of surfaces (see page 34-35), including concave, smoothed, sanded and solid surfaces. Our different surface structures have been put in different anti-slip quality classes according to BGR 181.

Straight cuts
Straight cuts are sections of panel material.

Cut edges
Grating areas which deviate from storage dimensions are sawn out of the panels. The sawn sides are known as cut edges, which should be permanently sealed.

Corrosion resistance
GRP gratings are known for their high corrosion resistance. The medium, its concentration, temperature and the duration of exposure have a major influence on the resistance.

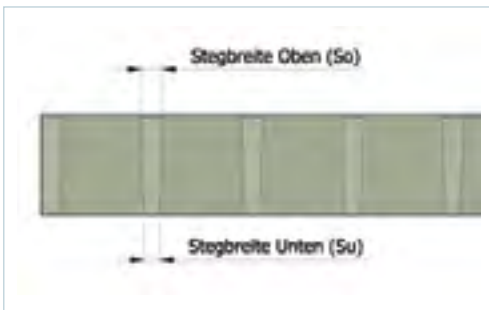

Land width
To press the GRP gratings out of the moulds, the support rods/crossbars are conically tapered. This leads to the upper land width (So) being larger than the lower land width (Su), measuring between 6 and 7 mm for a standard grating.

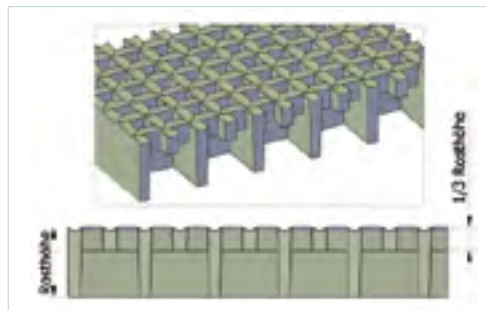

Micro mesh
The upper third of the mesh structure deviates from the basic mesh structure.

Moulded/monolithic
Moulded GRP gratings are produced in special moulds using a wet lamination procedure. The glass fibres are woven together, while the resin, additives and colour pigment if required are introduced in liquid form. After the material hardens, the GRP gratings are pressed out of the mould.

Pultruded
Pultrusion is a continuous profile production process. The term comes from the word "to pull". The glass fibre roving is immersed in resin and pulled through a mould.

DIN 24537-3
DIN 24537-3 – Gratings used as flooring – plastic gratings – contains information about the intended purpose and properties for the use of GRP gratings in flooring.

Resin designs
GRP gratings have a particularly high resistance to chemicals and corrosive elements. Different resin designs are used according to order specifications. Our standard resins are orthophthalic, isophthalic and vinyl ester resins.

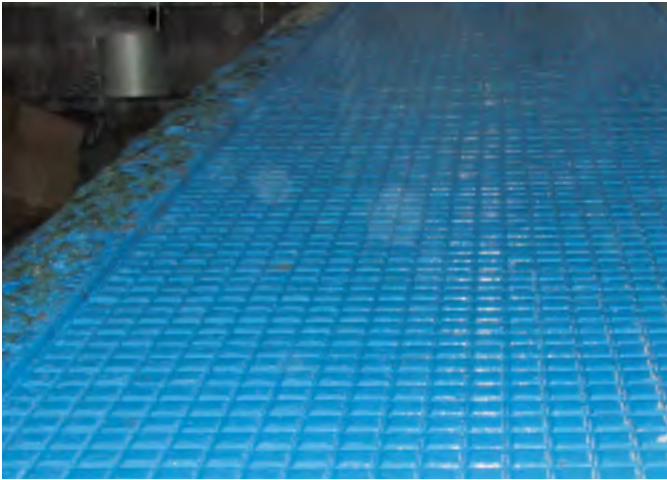

Top left:
Production of GRP grating

Top right:
Storage

Middle left:
Load test

Bottom left:
Flammability test

Bottom right:
Quality control of GRP grating



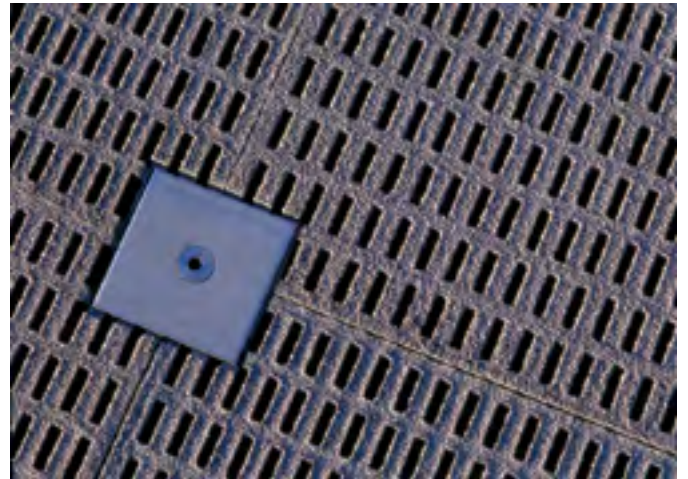
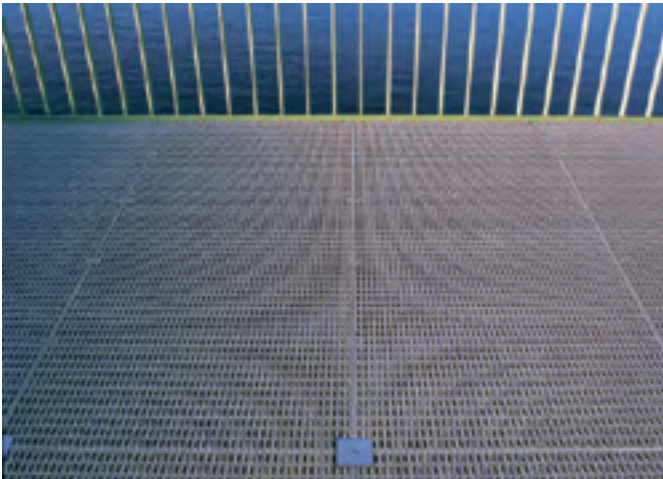
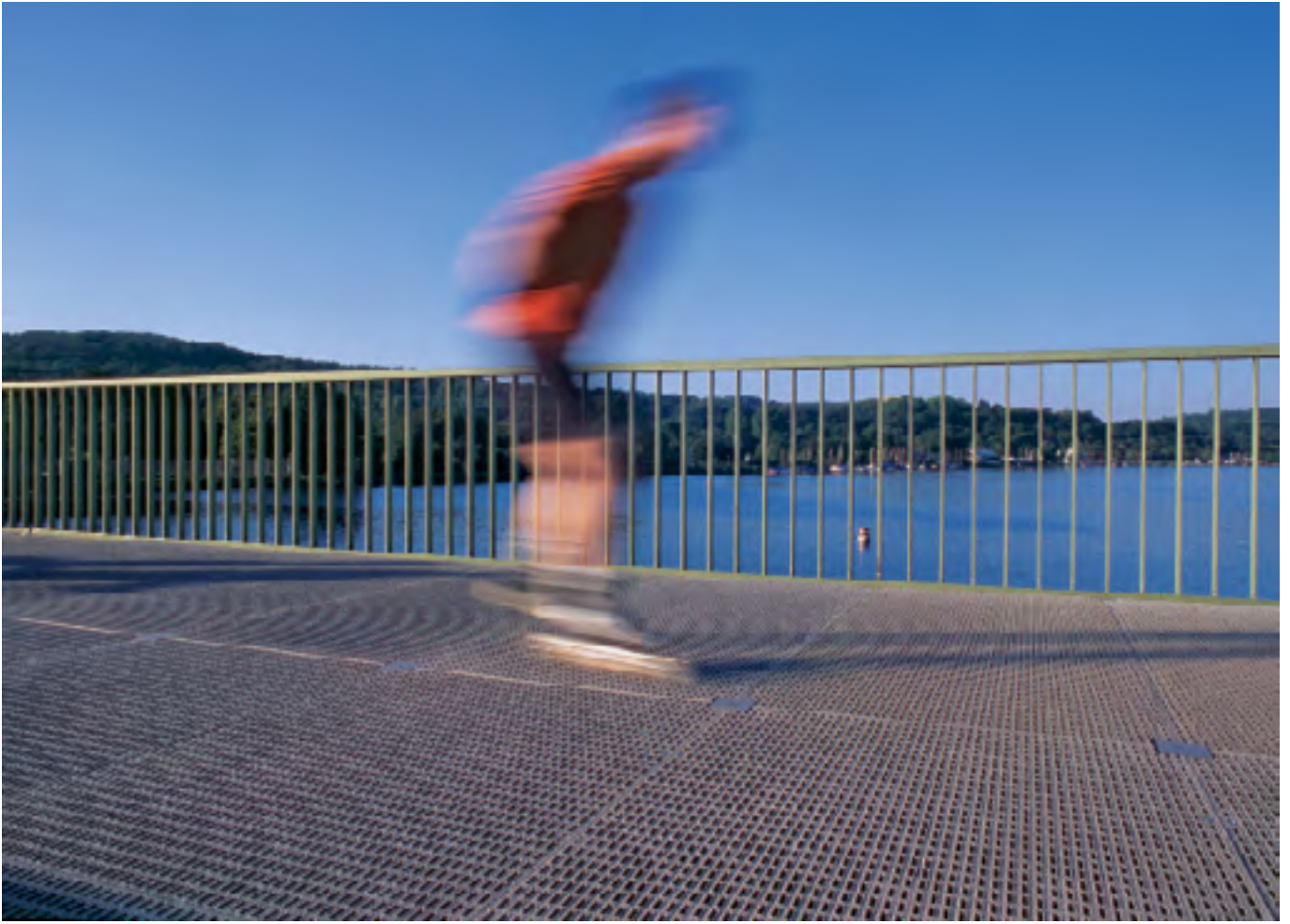

GRP grating as pedestrian
bridge covering



Top:
Conductive GRP gratings as a
custom-made item

Middle:
Walkway in the chemical
industry

Bottom:
GRP gratings installed on a
ship





Top:
GRP gratings in the chemical
industry



Top:
Anti-magnetic field: simply
composed of wood and GRP



Left:
Outside cleaning facility for
trains

Right:
Building cladding with trans-
parent GRP gratings



Moulded GRP gratings

Moulded GRP gratings are produced in special moulds using a wet lamination procedure. The glass fibres are woven together, while the resin, additives and colour pigment if required are introduced in liquid form. After the material hardens, the GRP gratings are pressed out of the mould.

Moulded GRP gratings have high levels of chemical resistance due to their high resin content (see page 37).

The storage dimensions are completely closed. Open edges may be present in the case of different dimensions. If required, the nearest production dimensions can be used instead (please see page 16 and following pages).

A range of surfaces are available, such as concave, smooth, sanded with quartz, sanded with corundum or solid. (see pages 34-35).

Advantages/characteristics of Lichtgitter GRP gratings

Chemical resistance

- High weather resistance
- High corrosion resistance
- High chemical resistance

Application/processing

- Moulded gratings are loadbearing in the direction of the supporting rods and the crossbars
- Relatively low unladen weight
- Simple and quick on-site assembly
- Simple processing and attachment

Ergonomics

- High levels of comfort for walking and standing
- Capable of absorbing impacts
- Sound absorbing

Safety

- Does not conduct electricity
- Anti-slip (up to R 13)
- No spark formation
- High impact resistance
- Long life span
- Low thermal diffusivity
- High thermal stability
- UV resistant
- Hygienic and bacteria-resistant
- Authorised for food industry (food resin)

Logistics

- Low transport costs
- Short delivery times
- Easily stored

Appearance

- Easily customised to fit difficult shapes
- Pigmentation possible (in a variety of RAL colours)

Usage areas

- Train technology
- Food and beverage industry
- Paper and wood pulp industry
- Pharmaceutical industry
- Vehicle and aeronautical construction
- Synthetic and rubber industry
- Offshore plants
- Naval and shipyards
- Textile fibre and textile paper industries
- Pickling and galvanizing plants
- Petrochemical industry
- Food processing industry
- Wastewater/sewage works

Range of applications

- Platform crossings
- Platforms, landings and walkways
- Control pedestals
- Stairtreads
- Ramps
- Covers for drains, manholes and sewers
- Production and transfer lines
- Shielding of dangerous areas
- Sewage works
- Chloride, bleaching and filter plants
- Kitchens

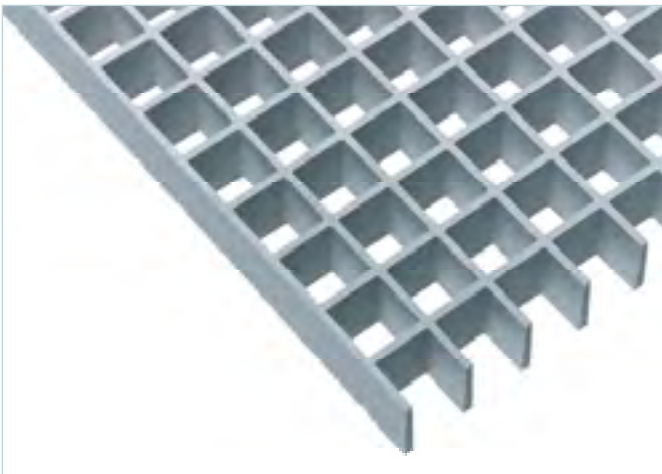

GRP components

Resin, glass fibres, additives and pigment are the basic components of the GRP compound material, which can be used in a variety of different areas on account of its shape and ease of use.

Resin

The chemical resistance, flexibility and UV resistance of the GRP product is determined by the resin used. A range of resins are available for use, depending on the intended purpose.

GRP products can be made from orthophthalic resin, isophthalic resin and vinyl ester resin (for extremely heavy chemical contamination); Lichtgitter uses isophthalic resin as standard. The distinguishing characteristic of phenolic resin is its flame resistance and very low smoke emission levels.

Glass fibres

Multi-layered continuous glass fibres are used to reinforce the material.

Additives

Additives such as hardeners, catalysts and UV stabilisers are other components of the material.

Pigments

Lichtgitter GRP gratings are grey as standard, similar to RAL 7035.

Colour pigments make it possible to give the GRP products a particular colour, providing a range of architectural design possibilities.

DIN 24537-3

The structural design of our GRP gratings comply with DIN standard 24537-3, "Gratings as floor coverings – part 3: plastic gratings" which was published in August 2007. Lichtgitter was also part of the Standards Committee involved in drawing up previous standards DIN 24537-1 and 24537-2.

We thought it important to draw up guidelines for the use of GRP gratings to ensure that the product could be used without encountering any problems.

Lichtgitter GRP gratings model codes

Example: GRP-K638-38-6

Material:	GRP
Surface:	-K
Supporting rod width:	5
Grating height:	38
Web spacing:	-38
Edge bar width:	-5
Code:	GRP-K 5 38 -38 -5

Model code as above, with a web spacing of 19 x 19 mm

	-19
Code:	GRP-K5 38 -19 -5

Resin designs

Orthophthalic resin:	medium chemical resistance
Isophthalic resin:	good chemical resistance
Vinyl ester resin:	very good chemical resistance
Phenolic resin:	positive flammability rating / smoke emission characteristics

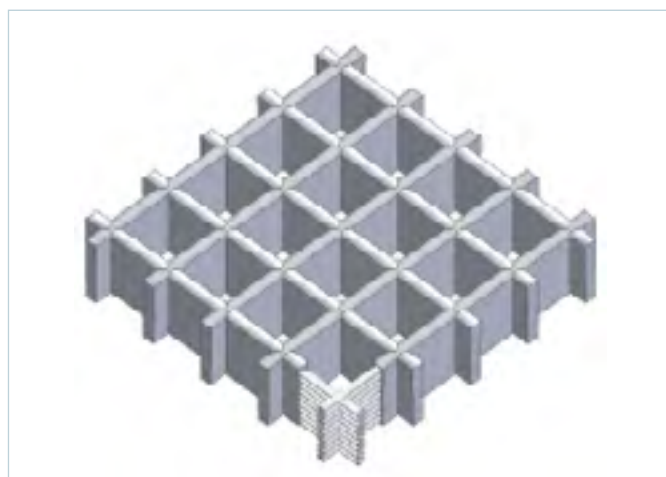

Gratings with concave surface
Walkway So 7 mm / Su 5 mm

GRP-K model | storage dimensions

Model code	Height mm	MT mm	MT mm	Panel dimensions mm	Weight kg/m ²
K 513-38-5	13	38.1 x 38.1	31 x 31	1226 x 3664	6.2
K 522-38-5	22	38.1 x 38.1	31 x 31	2445 x 1226	11
K 525-38-5	25	38.1 x 38.1	31 x 31	2445 x 1226 3665 x 1226	12.5 12.5
K 525-40-5	25	40.0 x 40.0	33 x 33	2000 x 1000	12.5
K 530-38-5	30	38.1 x 38.1	31 x 31	3055 x 922 2445 x 1226 3664 x 1226	15 15 15
K 530-40-5	30	40.0 x 40.0	33 x 33	2000 x 1000 3000 x 1000	14.5 14.5
K 538-38-5	38	38.1 x 38.1	31 x 31	3055 x 922 2445 x 1227 3665 x 1227 4046 x 998 3970 x 1531	19 19 19 19 19
K 538-40-5	38	40.0 x 40.0	33 x 33	2000 x 1000 3000 x 1000	19 19
K 550-50-5	50	50.8 x 50.8	44 x 44	3666 x 1227	21

Manufactured from high quality isophthalic resin, colour of storage dimensions grey, similar to Ral 7035. Other resins, colours and surfaces available on request.

MT = mesh spacing, MW = mesh width

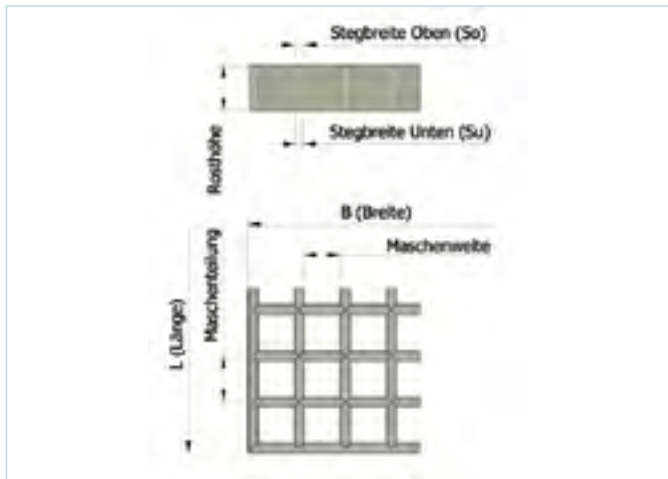

Calculation for self contained meshes
We calculate the dimensions of self contained meshes using the following formula:

(Desired grating size minus width of upper support bar So) divided by mesh spacing = number of meshes

$$L = (n \times MT) + So + \text{clearance}$$

The resulting number of meshes is then rounded up or down to the nearest value as necessary/requested. This value is then multiplied by the mesh spacing, and added to the land width plus the clearance allowance.

Example:
Required width: 750 mm (Blue)
Required length: 1200 mm (Blue)
Mesh spacing: 38.1 mm
Land width: 7.0 mm
Clearance allowance: 2.0 mm

Self contained meshes / rounded down dimensions (Green)
 $(750-7)/38.1 = 19.50 \rightarrow$ Selected value: 19
 $19 \times 38.1 + 7 + 2 = 733$ mm
 $(1200-7)/38.1 = 31.31 \rightarrow$ Selected value: 31
 $31 \times 38.1 + 7 + 2 = 1190$ mm

Self contained meshes / rounded up dimensions (Red)
 $(750-7)/38.1 = 19.50 \rightarrow$ Selected value: 20
 $20 \times 38.1 + 7 + 2 = 771$ mm
 $(1200-7)/38.1 = 31.31 \rightarrow$ Selected value: 32
 $32 \times 38.1 + 7 + 2 = 1228$ mm

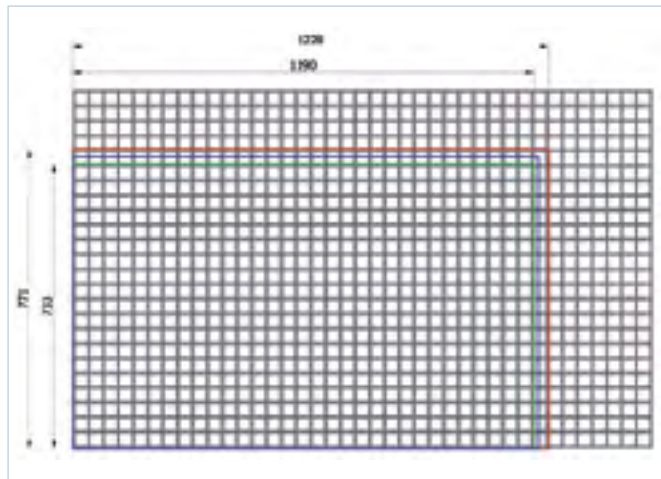

For more information on the mesh spacing please see DIN EN ISO 14122 - part 2

Grating with concave surface, close-mesh (micro)
Land width So 7 mm / Su 5 mm

GRP-K model | warehouse dimensions

Model code	Height mm	MT mm	MW mm	Panel dimensions mm	Weight kg/m ²
K 522-19-5	22	19.05 x 19.05	12 x 12	2445 x 1226	14.6
K 530-20-5	30	20.00 x 20.00	13 x 13	2000 x 1000 4000 x 1000	18.5 18.5
K 538-19-5	38	19.05 x 19.05	12 x 12	3665 x 1226 3665 x 1646	18.5 18.5
K 550-25-5	50	25.4 x 25.4	18 x 18	3666 x 1227 3665 x 1532 3666 x 1684	24,5 24,5 24,5

Manufactured from high quality isophthalic resin, colour of storage dimensions grey, similar to Ral 7035. Other resins, colours and surfaces available on request.

MT = mesh spacing, MW = mesh width

Grating with concave surface, heavy loads
Land width So 9 mm / Su 7 mm

GRP-KS model

Model code	Height mm	MT mm	MW mm	Panel dimensions mm	Weight kg/m ²
KS 750-38-7	50	38.1 x 38.1	29 x 29	3667 x 1229 3667 x 1536	33 33

Grating with concave surface, heavy loads
Land width So 11 mm / Su 9 mm

GRP-KS model

Model code	Height mm	MT mm	MW mm	Panel dimensions mm	Weight kg/m ²
KS 950-38-9	50	38.1 x 38.1	27 x 27	3669 x 1231	40
KS 960-38-9	60	38.1 x 38.1	27 x 27	3669 x 1231	44

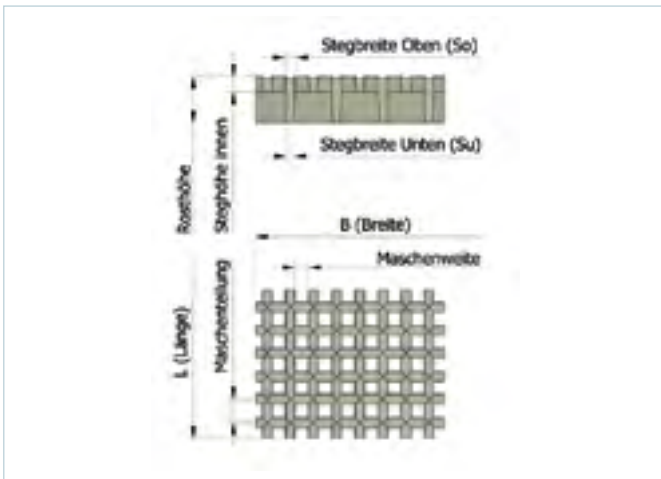

Gratings in accordance with DIN 24537-3

GRP-K model

Model code	Grating height	Mesh spacing	kg/m ²		Span mm						
					200	300	400	450	500	550	600
GRP-K 525-38-5	25 mm	38 x 38 mm	12.5	Fp	18.45	9.23	6.15	5.91	5.17	5.09	4.58
				f1	2.90	6.38	11.02	13.78	16.82	20.16	23.79
				Fv	293.86	130.60	73.46	58.05	47.02	38.86	32.65
				f	2.90	6.53	11.60	14.69	18.13	21.94	26.11
GRP-K 530-38-5	30 mm	38 x 38 mm	15	Fp	26.57	13.29	8.86	7.59	6.64	6.62	5.96
				f1	2.42	5.32	9.19	11.48	14.02	16.80	19.82
				Fv	423.16	188.07	105.79	83.59	67.71	55.95	47.02
				f	2.42	5.44	9.67	12.24	15.11	18.28	21.76
GRP-K 538-38-5	38 mm	38 x 38 mm	18.5	Fp	42.64	21.32	14.21	12.18	10.66	9.47	8.53
				f1	1.91	4.20	7.25	9.06	11.07	13.26	15.65
				Fv	678.93	301.75	169.73	134.11	108.63	89.78	75.44
				f	1.91	4.29	7.63	9.66	11.93	14.43	17.18
GRP-K 550-50-5	50 mm	50 x 50 mm	21.5	Fp	62.53	31.27	20.84	17.87	15.63	13.90	12.51
				f1	1.45	3.19	5.51	6.89	8.41	10.08	11.89
				Fv	893.33	397.04	223.33	176.46	142.93	118.13	99.26
				f	1.45	3.26	5.80	7.34	9.06	10.97	13.05
GRP-K 530-20-5	30 mm	20 x 20 mm	17.5	Fp	25.94	12.97	8.65	7.41	6.49	6.49	5.84
				f1	2.42	5.32	9.19	11.48	14.02	16.80	19.82
				Fv	810.70	360.31	202.68	160.14	129.71	107.20	90.08
				f	2.42	5.44	9.67	12.24	15.11	18.28	21.76
GRP-K 538-19-5	38 mm	19 x 19 mm	22.5	Fp	41.62	20.81	13.87	11.89	10.41	9.25	8.32
				f1	1.91	4.20	7.25	9.06	11.07	13.26	15.65
				Fv	650.36	289.05	162.59	128.47	104.06	86.00	72.26
				f	1.91	4.29	7.63	9.66	11.93	14.43	17.18
GRP-KS 750-38-7	50 mm	38 x 38 mm	30.5	Fp	86.12	43.06	28.71	24.61	21.53	19.14	17.22
				f1	1.45	3.19	5.51	6.89	8.41	10.08	11.89
				Fv	1371.35	609.49	342.84	270.88	219.42	181.33	152.37
				f	1.45	3.26	5.80	7.34	9.06	10.97	13.05
GRP-KS 950-38-9	50 mm	38 x 38 mm	34	Fp	110.73	55.36	36.91	31.64	27.68	24.61	22.15
				f1	1.45	3.19	5.51	6.89	8.41	10.08	11.89
				Fv	1763.16	783.63	440.79	348.28	282.11	233.14	195.91
				f	1.45	3.26	5.80	7.34	9.06	10.97	13.05
GRP-KS 960-38-9	60 mm	38 x 38 mm	44	Fp	159.45	79.72	53.15	45.56	39.86	35.43	31.89
				f1	1.21	2.66	4.59	5.74	7.01	8.40	9.91
				Fv	2538.95	1128.42	634.74	501.52	406.23	335.73	282.11
				f	1.21	2.72	4.83	6.12	7.55	9.14	10.88

Legend

Fv = load values for equally distributed load in kN/m²

f = deviation in mm at load Fv

Fp = load values for a centrally placed point load in kN and a contact area of 200 x 200 mm

f1 = deviation in mm at point load Fp

1 kN = 1000 N ~ 100 kg

Example

The values in the table indicate the max. thresholds. Because of the linear behaviour of the material, these values can be used to calculate any necessary status according to requirements. For this example we will use grating model GRP-K 638-38-6 with a span of 700 mm.

Max. deviation + max. point load x required point load = corresponding deviation
 20.99 mm + 7.97 kN x 1.5 kN = 3.95 mm

Multiplication factors

Mesh spacing
40 x 40Distributed load capacity
0.97Point load
0.95

Safety factor

to breaking limit: 3.0

Deterioration coefficient

at deviation: 1.3

The initial safety value in the table is 3.0 in compliance with the breaking and deviation deterioration coefficients laid down in DIN 24537-3. The values in the table do not apply if different forces are used!

Span mm	650	700	750	800	850	900	950	1000	1050	1100	1150	1200	1300	1400	1500
4.57	4.19	3.87	3.91	3.65	3.42	3.22	3.04	2.88	2.74	2.61	2.49	2.28	2.11	2.11	0.84
27.70	31.91	36.40	41.19	46.27	51.63	57.29	63.24	69.47	76.00	82.82	89.92	105.01	121.25	121.25	138.66
27.82	23.99	20.90	18.37	16.27	14.51	13.02	11.75	10.66	9.71	8.89	8.16	6.96	6.00	6.00	5.22
30.64	35.53	40.79	46.41	52.40	58.74	65.45	72.52	79.95	87.75	95.91	104.43	122.56	142.14	142.14	163.17
6.00	5.50	5.08	5.17	4.83	4.53	4.64	4.38	4.15	3.94	3.76	3.59	3.29	3.03	3.03	2.82
23.09	26.59	30.34	34.33	38.56	43.03	47.74	52.70	57.90	63.33	69.01	74.94	87.51	101.04	101.04	115.55
40.06	34.54	30.09	26.45	23.43	20.90	18.75	16.93	15.35	13.99	12.80	11.75	10.02	8.64	8.64	7.52
25.53	29.61	33.99	38.68	43.66	48.95	54.54	60.43	66.63	73.12	79.92	87.02	102.13	118.45	118.45	135.97
8.69	7.97	7.35	6.83	7.06	6.62	6.23	6.46	6.12	5.81	5.53	5.75	5.27	4.87	4.87	4.52
18.23	20.99	23.95	27.10	30.44	33.97	37.69	41.60	45.71	50.00	54.49	59.16	69.08	79.77	79.77	91.22
64.28	55.42	48.28	42.43	37.59	33.53	30.09	27.16	24.63	22.44	20.53	18.86	16.07	13.86	13.86	12.07
20.16	23.38	26.84	30.53	34.47	38.65	43.06	47.71	52.60	57.73	63.10	68.70	80.63	93.51	93.51	107.35
11.37	10.42	9.62	10.21	9.53	8.93	8.41	7.94	8.46	8.04	7.66	8.12	7.44	6.87	6.87	7.02
13.85	15.95	18.20	20.60	23.13	25.82	28.65	31.62	34.74	38.00	41.41	44.96	52.50	60.63	60.63	69.33
84.58	72.93	63.53	55.83	49.46	44.12	39.59	35.73	32.41	29.53	27.02	24.81	21.14	18.23	18.23	15.88
15.32	17.77	20.40	23.21	26.20	29.37	32.72	36.26	39.98	43.87	47.95	52.21	61.28	71.07	71.07	81.58
5.90	5.40	5.49	5.10	4.76	4.46	4.58	4.32	4.10	3.89	3.71	3.54	3.24	2.99	2.99	2.78
23.09	26.59	30.34	34.33	38.56	43.03	47.74	52.70	57.90	63.33	69.01	74.94	87.51	101.04	101.04	115.55
76.75	66.18	57.65	50.67	44.88	40.03	35.93	32.43	29.41	26.80	24.52	22.52	19.19	16.54	16.54	14.41
25.53	29.61	33.99	38.68	43.66	48.95	54.54	60.43	66.63	73.12	79.92	87.02	102.13	118.45	118.45	135.97
7.57	7.80	7.20	7.43	6.94	6.50	6.12	6.36	6.02	5.72	5.45	5.68	5.20	4.80	4.80	4.46
18.23	20.99	23.95	27.10	30.44	33.97	37.69	41.60	45.71	50.00	54.49	59.16	69.08	79.77	79.77	91.22
61.57	53.09	46.25	40.65	36.01	32.12	28.82	26.01	23.60	21.50	19.67	18.07	15.39	13.27	13.27	11.56
20.16	23.38	26.84	30.53	34.47	38.65	43.06	47.71	52.60	57.73	63.10	68.70	80.63	93.51	93.51	107.35
15.66	14.35	13.25	12.30	12.87	12.07	11.36	10.73	10.16	9.65	10.19	9.72	8.91	9.03	9.03	8.38
13.85	15.95	18.20	20.60	23.13	25.82	28.65	31.62	34.74	38.00	41.41	44.96	52.50	60.63	60.63	69.33
129.83	111.95	97.52	85.71	75.92	67.72	60.78	54.85	49.75	45.33	41.48	38.09	32.46	27.99	27.99	24.38
15.32	17.77	20.40	23.21	26.20	29.37	32.72	36.26	39.98	43.87	47.95	52.21	61.28	71.09	71.09	81.58
20.13	18.45	17.03	15.82	14.76	13.84	14.60	13.79	13.07	12.41	11.82	11.28	11.46	10.58	10.58	10.78
13.85	15.85	18.20	20.60	23.13	25.82	28.65	31.62	34.74	38.00	41.41	44.96	52.50	60.63	60.63	69.33
166.93	143.93	125.38	110.20	97.61	87.07	78.15	70.53	63.97	58.29	53.33	48.98	41.73	35.98	35.98	31.35
15.32	17.77	20.40	23.21	26.20	29.37	32.72	36.26	39.98	43.87	47.95	52.21	61.28	71.07	71.07	81.58
28.99	26.57	24.53	22.78	21.26	19.93	18.76	17.72	16.78	15.94	17.02	16.25	14.90	13.75	13.75	14.15
11.54	13.30	15.17	17.16	19.28	21.51	23.87	26.35	28.95	31.67	34.51	37.47	43.75	50.52	50.52	57.77
240.37	207.26	180.55	158.68	140.56	125.38	112.53	101.56	92.12	83.93	76.79	70.53	60.09	51.82	51.82	45.14
12.77	14.81	17.00	19.34	21.83	24.48	27.27	30.22	33.31	36.56	39.96	43.51	51.07	59.22	59.22	67.99

Accessibility (highlighted yellow):
 Please refer to DIN 24537-3, the stipulations of the Employer's Liability Insurance Association in instruction sheet BGI 588 and the quality assurance conditions for gratings in RAL-GZ 638 for more information on accessibility. These values assume that accessibility will be completely unimpaired if gratings are dimensioned so that the weakest point can support a point load of at least 1.5 kN with a load contact surface 200 x 200 mm in size. Deviation due to the load may be no more than 1/200 of the land width and the difference in height between neighbouring joints between loaded and unloaded floor coverings may be no more than 4 mm.

Before the blue mark:
 At a distributed actual load of 5 kN/m² the maximum deviation will be 1/200 of the span at this threshold.

Grating with smooth surface
Land width So 8 mm / Su 6 mm

GRP-G model

Model code	Height mm	MT mm	MW mm	Panel dimensions mm	Weight kg/m ²
G 615-38-6	15	38.35 x 38.35	31 x 31	2002 x 1002	7.5
				2502 x 1002	7.5
				3002 x 1002	7.5
				2002 x 1312	7.5
				2502 x 1312	7.5
G 620-38-6	20	38.35 x 38.35	31 x 31	2002 x 1002	10
				2502 x 1002	10
				3002 x 1002	10
				2002 x 1312	10
				2502 x 1312	10
G 625-38-6	25	38.35 x 38.35	31 x 31	2002 x 1002	12.5
				2502 x 1002	12.5
				3002 x 1002	12.5
				2002 x 1312	12.5
				2502 x 1312	12.5
G 628-38-6	28	38.35 x 38.35	31 x 31	2002 x 1002	13.5
				2502 x 1002	13.5
				3002 x 1002	13.5
				2002 x 1312	13.5
				2502 x 1312	13.5
G 630-38-6	30	38.35 x 38.35	31 x 31	2002 x 1002	15
				2502 x 1002	15
				3002 x 1002	15
				2002 x 1312	15
				2502 x 1312	15
G 635-38-6	35	38.35 x 38.35	31 x 31	2002 x 1002	17
				2502 x 1002	17
				3002 x 1002	17
				2002 x 1312	17
				2502 x 1312	17
G 638-38-6	38	38,35 x 38,35	31 x 31	2002 x 1002	18.5
				2502 x 1002	18.5
				3002 x 1002	18.5
				2002 x 1312	18.5
				2502 x 1312	18.5
G 640-38-6	38	38.35 x 38.35	31 x 31	2002 x 1002	19.5
				2502 x 1002	19.5
				3002 x 1002	19.5
				2002 x 1312	19.5
				2502 x 1312	19.5

Manufactured from high quality resin, standard colour grey, similar to Ral 7042. Other resins, colours and surfaces available on request.
MT = mesh spacing, MW = mesh width

Calculation for self contained meshes

We calculate the dimensions of self contained meshes using the following formula:

(Desired grating size minus width of upper support bar So) divided by mesh spacing = number of meshes

$$L = (n \times MT) + So + \text{clearance}$$

The resulting number of meshes is then rounded up or down to the nearest value as necessary/requested. This value is then multiplied by the mesh spacing, and added to the land width plus the clearance allowance.

Example:

Required width: 750 mm
Required length: 1200 mm
Mesh spacing: 38.35 mm
Land width: 8.0 mm
Clearance allowance: 2.0 mm

Self contained meshes / rounded down dimensions (green)

$(750-8)/38.35 = 19.35 \rightarrow$ selected value: 19
 $19 \times 38.35 + 8 + 2 = 739$ mm
 $(1200-8)/38.35 = 31.08 \rightarrow$ selected value: 31
 $31 \times 38.35 + 8 + 2 = 1199$ mm

Self contained meshes / rounded up dimensions

$(750-8)/38.35 = 19.35 \rightarrow$ selected value: 20
 $20 \times 38.35 + 8 + 2 = 777$ mm
 $(1200-8)/38.35 = 31.08 \rightarrow$ selected value: 32
 $32 \times 38.35 + 8 + 2 = 1237$ mm

For more information on the mesh spacing please see DIN EN ISO 14122 - part 2

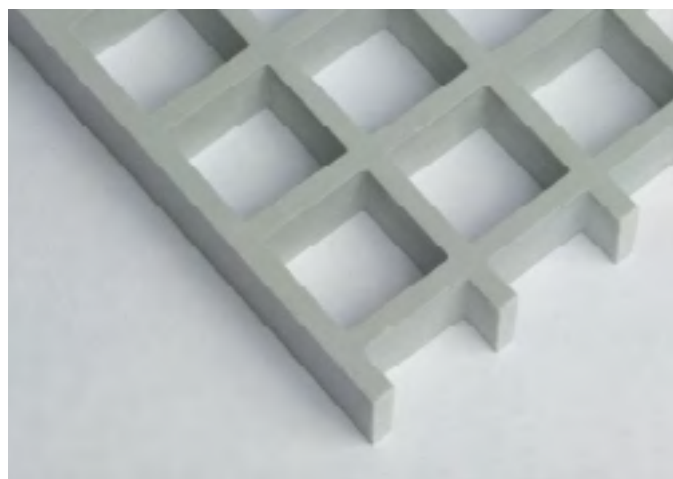
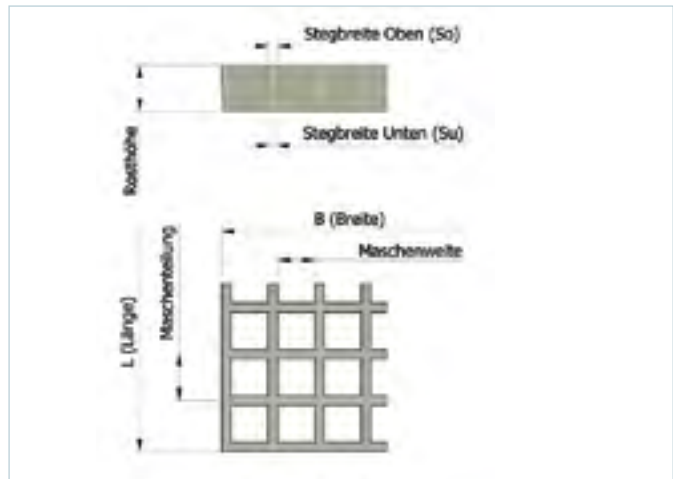

Grating with smooth surface
Land width So 8 mm / Su 6 mm

GRP-G model

Model code	Height mm	MT mm	MW mm	Panel dimensions mm	Weight kg/m ²
G 630-19-6	30	19.18 x 19.18	12 x 12	2002 x 1002	17
G 635-19-6	35	19.18 x 19.18	12 x 12	2002 x 1002	20
G 630-25-6	30	25.00 x 25.00	17 x 17	2002 x 1302	16
G 635-25-6	35	25.00 x 25.00	17 x 17	2002 x 1302	18.5

Manufactured from high quality resin, standard colour grey, similar to Ral 7042. Other resins, colours and surfaces available on request.
MT = mesh spacing, MW = mesh width

Grating with smooth surface
Land width 8 mm / Su 6 mm

GRP-G model

Model code	Height mm	MT mm	MW mm	Panel dimensions mm	Weight kg/m ²
G 625-21/51-6	25	21.7 x 51.2	13 x 43	2002 x 1002	16.5
G 628-21/51-6	28	21.7 x 51.2	13 x 43	2002 x 1002	18.5
G 630-21/51-6	30	21.7 x 51.2	13 x 43	2002 x 1002	20.5
G 635-21/51-6	35	21.7 x 51.2	13 x 43	2002 x 1002	24

Manufactured from high quality resin, standard colour grey, similar to Ral 7042. Other resins, colours and surfaces available on request.
MT = mesh spacing, MW = mesh width

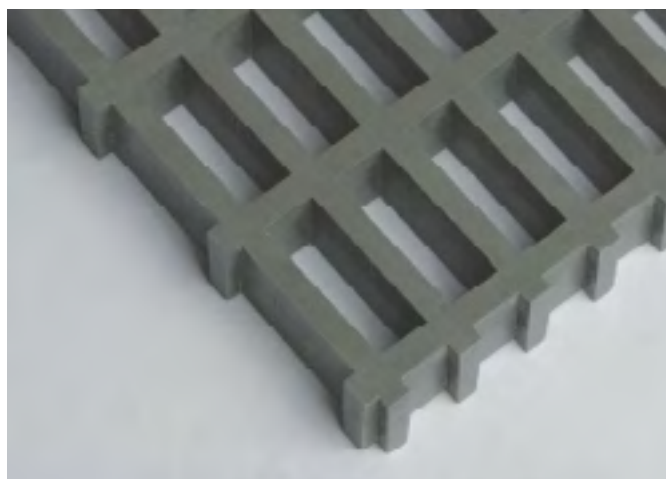
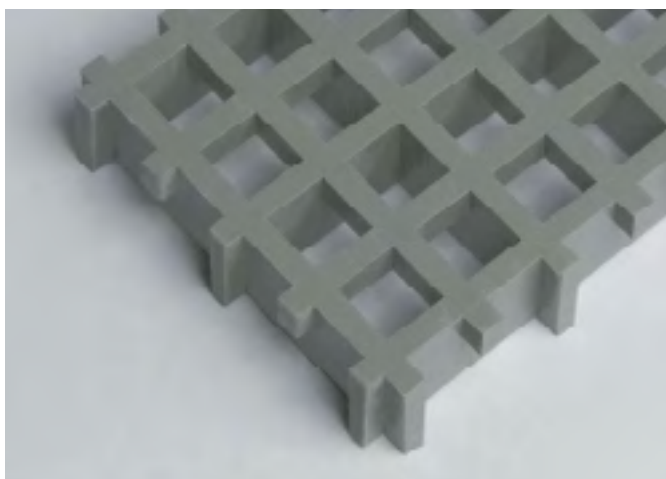
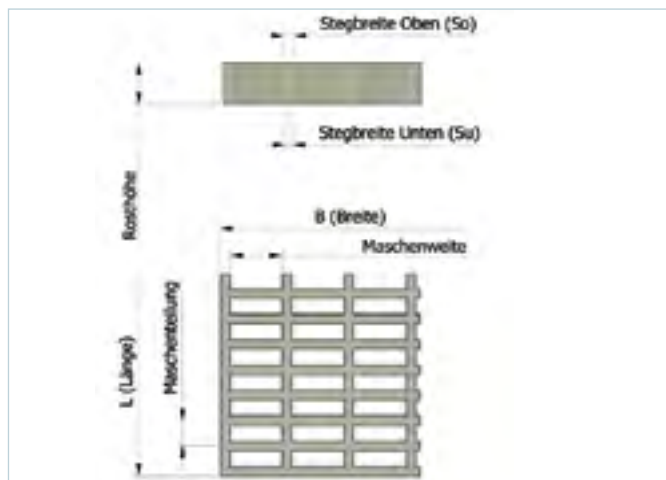
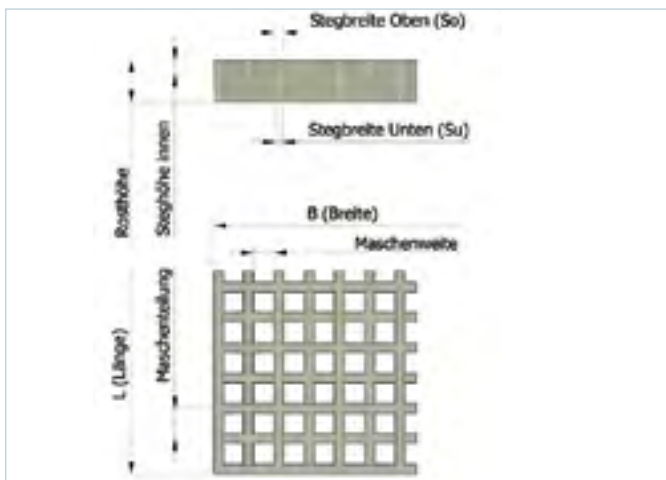

Gratings in accordance with DIN 24537-3

GRP-G model

Model code	Grating height	Mesh spacing	kg/m ²		Span mm						
					200	300	400	450	500	550	600
GRP-G 615-38-6	15 mm	38 x 38 mm	7.5	Fp	6.64	3.72	3.02	2.59	2.26	2.19	1.97
				f1	4.51	9.92	17.14	21.42	26.16	31.34	36.98
				Fv	105.79	47.02	26.45	20.90	16.93	13.99	11.75
				f	4.51	10.15	18.04	22.83	28.19	34.11	40.59
GRP-G 620-38-6	20 mm	38 x 38 mm	10	Fp	11.81	5.91	4.41	4.19	3.67	3.58	3.22
				f1	3.38	7.44	12.85	16.07	19.62	23.51	27.74
				Fv	188.07	83.59	47.02	37.15	30.09	24.87	20.90
				f	3.38	7.61	13.53	17.12	21.14	25.58	30.44
GRP-G 625-38-6	25 mm	38 x 38 mm	12.5	Fp	18.45	9.23	6.15	5.91	5.17	5.09	4.58
				f1	2.71	5.95	10.28	12.85	15.69	18.81	22.19
				Fv	293.86	130.60	73.46	58.05	47.02	38.86	32.65
				f	2.71	6.09	10.82	13.70	16.91	20.46	24.35
GRP-G 628-38-6	28 mm	38 x 38 mm	13.5	Fp	23.15	11.57	7.72	6.61	6.49	5.77	5.19
				f1	2.42	5.32	9.18	11.48	14.01	16.79	19.81
				Fv	368.62	163.83	92.15	72.81	58.98	48.74	40.96
				f	2.42	5.44	9.66	12.23	15.10	18.27	21.74
GRP-G 630-38-6	30 mm	38 x 38 mm	15	Fp	26.57	13.29	8.86	7.59	6.64	6.62	5.96
				f1	2.25	4.96	8.57	10.71	13.08	15.67	18.49
				Fv	423.16	188.07	105.79	83.59	67.71	55.95	47.02
				f	2.25	5.07	9.02	11.42	14.09	17.05	20.29
GRP-G 635-38-6	35 mm	38 x 38 mm	17	Fp	36.17	18.09	12.06	10.33	9.04	8.04	7.23
				f1	1.93	4.25	7.34	9.18	11.21	13.43	15.85
				Fv	575.96	255.98	143.99	113.77	92.15	76.16	64.00
				f	1.93	4.35	7.73	9.78	12.08	14.62	17.40
GRP-G 638-38-6	38 mm	38 x 38 mm	18.5	Fp	42.64	21.32	14.21	12.18	10.66	9.47	8.53
				f1	1.78	3.92	6.76	8.46	10.33	12.37	14.60
				Fv	678.93	301.75	169.73	134.11	108.63	89.78	75.44
				f	1.78	4.01	7.12	9.01	11.13	13.46	16.02
GRP-G 640-38-6	40 mm	38 x 38 mm	19.5	Fp	47.24	23.62	15.75	13.50	11.81	10.50	9.45
				f1	1.69	3.72	6.43	8.03	9.81	11.75	13.07
				Fv	752.28	334.35	188.07	148.60	120.36	99.48	83.59
				f	1.69	3.81	6.76	8.56	10.57	12.79	15.22

Legend

Fv = load values for equally distributed load in kN/m²

f = deviation in mm at load Fv

Fp = load values for a centrally placed point load in kN and a contact area of 200 x 200 mm

f1 = deviation in mm at point load Fp

1 kN = 1000 N ~ 100 kg

Example

The values in the table indicate the max. thresholds. Because of the linear behaviour of the material, these values can be used to calculate any necessary status according to requirements. For this example we will use grating model GRP-G 640-38-6 with a span of 700 mm.

Max. deviation + max. point load x required point load = corresponding deviation

18.6 mm ÷ 7.87 kN x 1.5 kN = 3.545 mm

Safety factor

to breaking limit: 3.0

Deterioration coefficient

at deviation: 1.3

The initial safety value in the table is 3.0 in compliance with the breaking and deviation deterioration coefficients laid down in DIN 24537-3. The values in the table do not apply if different forces are used!

Span mm	650	700	750	800	850	900	950	1000	1050	1100	1150	1200	1300	1400	1500
1.79	1.64	1.52	1.41	1.31	1.23	0.50	0.47	0.45	0.42	0.40	0.38	0.35	0.33	0.30	
43.07	49.61	56.60	64.04	71.93	80.28	89.07	98.32	108.01	118.16	128.76	139.81	163.26	188.51	215.57	
10.02	8.64	7.52	6.61	5.86	5.22	4.69	4.23	3.84	3.50	3.20	2.94	2.50	2.16	1.88	
47.64	55.25	63.42	72.16	81.46	91.33	101.75	112.75	124.30	136.42	149.11	162.36	190.54	220.98	153.68	
3.19	2.92	2.70	2.50	2.34	2.19	2.06	1.95	1.85	1.75	1.67	1.59	0.63	0.58	0.54	
32.30	37.21	42.45	48.03	53.95	60.21	66.80	73.74	81.01	88.62	96.57	104.85	122.44	141.39	161.68	
17.81	15.35	13.37	11.75	10.41	9.29	8.34	7.52	6.82	6.22	5.69	5.22	4.45	3.84	3.34	
35.73	41.43	47.57	54.12	61.09	68.49	76.32	84.56	93.23	102.32	111.83	121.77	142.91	165.74	190.26	
4.17	4.19	3.87	2.96	3.65	3.42	3.22	3.04	2.88	2.74	2.61	2.49	2.28	2.11	1.96	
25.84	29.77	33.96	38.42	43.16	48.17	53.44	58.99	64.81	70.90	77.25	83.88	97.95	113.11	129.34	
27.82	23.99	20.90	18.37	16.27	14.51	13.02	11.75	10.66	9.71	8.89	8.16	6.96	6.00	5.22	
28.58	33.15	38.05	43.29	48.88	54.80	61.05	67.65	74.58	81.85	89.46	97.41	114.33	132.59	152.21	
5.23	4.79	4.85	4.51	4.21	3.94	4.04	3.82	3.62	3.44	3.27	3.12	2.86	2.64	2.45	
23.07	26.58	30.32	34.31	38.54	43.01	47.72	52.67	57.86	63.30	68.98	74.90	87.46	100.99	115.49	
34.90	30.09	26.21	23.04	20.41	18.20	16.34	14.74	13.37	12.19	11.15	10.24	8.72	7.52	6.55	
25.52	29.60	33.98	38.66	43.64	48.92	54.51	60.40	66.59	73.08	79.88	86.98	102.08	118.38	135.90	
5.42	4.97	5.08	4.72	4.83	4.53	3.13	4.38	4.15	3.94	3.76	3.59	3.29	3.03	2.82	
21.53	24.80	28.30	32.02	35.97	40.14	44.54	49.16	54.01	59.08	64.38	69.90	81.63	94.26	107.79	
40.06	34.54	30.09	26.45	23.43	20.90	18.75	16.93	15.35	13.99	12.80	11.75	10.02	8.64	7.52	
23.82	27.62	31.71	36.08	40.73	45.66	50.88	56.37	62.15	68.21	74.55	81.18	95.27	110.49	126.84	
7.37	6.76	6.24	5.79	5.99	5.62	5.80	5.48	5.19	4.93	5.11	4.88	4.47	4.13	3.83	
18.46	21.26	24.26	27.45	30.83	34.40	38.17	42.14	46.29	50.64	55.18	59.92	69.97	80.79	92.39	
54.53	47.02	40.96	36.00	31.89	28.44	25.53	23.04	20.90	19.04	17.42	16.00	13.63	11.75	10.24	
20.42	23.68	27.18	30.92	34.91	39.14	43.61	48.32	53.27	58.47	63.90	69.58	81.66	94.71	108.72	
7.75	7.97	7.35	6.83	6.37	6.62	6.23	6.46	6.12	5.81	5.53	5.75	5.27	4.87	4.52	
17.00	19.58	22.34	25.28	28.39	31.69	35.15	38.81	42.64	46.64	50.83	55.19	64.44	74.41	85.09	
64.28	55.42	48.28	42.43	37.59	33.53	30.09	27.16	24.63	22.44	20.53	18.86	16.07	13.86	12.07	
18.80	21.81	25.03	28.48	32.16	36.05	40.17	44.51	49.07	53.85	58.86	64.09	75.21	87.23	100.14	
8.59	7.87	8.15	7.57	7.06	6.62	6.90	6.52	4.97	6.44	6.13	5.85	5.37	5.39	5.01	
16.15	18.60	21.22	24.02	26.97	30.10	33.40	36.87	40.50	44.31	48.28	52.43	61.22	70.69	80.84	
71.22	61.41	53.50	47.02	41.65	37.15	33.34	30.09	27.29	24.87	22.75	20.90	17.81	15.35	13.37	
17.86	20.72	23.78	27.06	30.55	34.25	38.16	42.28	46.61	51.16	55.92	60.88	71.45	82.87	95.13	

Accessibility (highlighted yellow):
 Please refer to DIN 24537-3, the stipulations of the Employer's Liability Insurance Association in instruction sheet BGI 588 and the quality assurance conditions for gratings in RAL-GZ 638 for more information on accessibility. These values assume that accessibility will be completely unimpaired if gratings are dimensioned so that the weakest point can support a point load of at least 1.5 kN with a load contact surface 200 x 200 mm in size. Deviation due to the load may be no more than 1/200 of the land width and the difference in height between neighbouring joints between loaded and unloaded floor coverings may be no more than 4 mm.

Before the blue mark:
 At a distributed actual load of 5 kN/m² the maximum deviation will be 1/200 of the span at this threshold.

Gratings in accordance with DIN 24537-3

GRP-G model

Model code	Grating height	Mesh spacing	kg/m ²		Span mm						
					200	300	400	450	500	550	600
GRP-G 625-21/51-6	25 mm	21 x 51 mm	16.5	Fp	27.97	13.98	9.32	7.99	6.99	6.71	6.04
				f1	2.71	5.95	10.28	12.85	15.69	18.81	22.19
				Fv	531.75	236.33	132.94	105.04	85.08	70.31	59.08
				f	2.71	6.09	10.82	13.70	16.91	20.46	24.35
GRP-G 628-21/51-6	28 mm	21 x 51 mm	18.5	Fp	35.09	17.54	11.70	10.02	8.77	7.80	7.58
				f1	2.42	5.32	9.18	11.48	14.01	16.79	19.81
				Fv	667.02	296.45	166.76	131.76	106.72	88.20	74.11
				f	2.42	5.44	9.66	12.23	15.10	18.27	21.74
GRP-G 630-21/51-6	30 mm	21 x 51 mm	20.5	Fp	40.28	20.14	13.43	11.51	10.07	8.95	8.06
				f1	2.25	4.96	8.57	10.71	13.08	15.67	18.49
				Fv	765.71	340.32	191.43	151.25	122.51	101.25	85.08
				f	2.25	5.07	9.02	11.42	14.09	17.05	20.29
GRP-G 635-21/51-6	35 mm	21 x 51 mm	24	Fp	54.82	27.41	18.27	15.66	13.71	12.18	10.96
				f1	1.93	4.25	7.34	9.18	11.21	13.43	15.85
				Fv	1042.22	463.21	260.56	205.87	166.76	137.81	115.80
				f	1.93	4.35	7.73	9.78	12.08	14.62	17.40
GRP-G 630-19-6	30 mm	19 x 19 mm	18	Fp	26.80	13.40	8.93	7.66	6.70	6.68	6.01
				f1	2.25	4.96	8.57	10.71	13.08	15.67	18.49
				Fv	426.68	189.64	106.67	84.28	68.27	56.42	47.41
				f	2.25	5.07	9.02	11.42	14.09	17.05	20.29
GRP-G 635-19-6	35 mm	19 x 19 mm	20	Fp	36.47	18.24	12.16	10.42	9.12	8.10	8.18
				f1	1.93	4.25	7.34	9.18	11.21	13.43	15.85
				Fv	580.76	258.12	145.19	114.72	92.92	76.80	64.53
				f	1.93	4.35	7.73	9.78	12.08	14.62	17.40
GRP-G 630-25-6	30 mm	25 x 25 mm	16	Fp	35.38	17.69	11.79	10.11	8.84	7.86	7.72
				f1	2.25	4.96	8.57	10.71	13.08	15.67	18.49
				Fv	643.20	285.87	160.80	127.05	102.91	85.05	71.47
				f	2.25	5.07	9.02	11.42	14.09	17.05	20.29
GRP-G 635-25-6	35 mm	25 x 25 mm	18.5	Fp	48.15	24.08	16.05	13.76	12.04	10.70	9.63
				f1	1.93	4.25	7.34	9.18	11.21	13.43	15.85
				Fv	875.47	389.10	218.87	172.93	140.07	115.76	97.27
				f	1.93	4.35	7.73	9.78	12.08	14.62	17.40

Legend

Fv = load values for equally distributed load in kN/m²

f = deviation in mm at load Fv

Fp = load values for a centrally placed point load in kN and a contact area of 200 x 200 mm

f1 = deviation in mm at point load Fp

1 kN = 1000 N ~ 100 kg

Example

The values in the table indicate the max. thresholds. Because of the linear behaviour of the material, these values can be used to calculate any necessary status according to requirements. For this example we will use grating model GRP-G 635-25-6 with a span of 700 mm.

Max. deviation + max. point load x required point load = corresponding deviation

21.26 mm ÷ 8.75 kN x 1.5 kN = 3.645 mm

Safety factor

to breaking limit: 3.0

Deterioration coefficient

at deviation: 1.3

The initial safety value in the table is 3.0 in compliance with the breaking and deviation deterioration coefficients laid down in DIN 24537-3. The values in the table do not apply if different forces are used!

Span mm	650	700	750	800	850	900	950	1000	1050	1100	1150	1200	1300	1400	1500
5.90	5.41	5.33	4.95	4.62	4.33	4.34	4.10	3.88	3.69	3.51	3.35	3.08	2.84	2.64	
25.84	29.77	33.96	38.42	43.16	48.17	53.44	58.99	64.81	70.90	77.25	83.88	97.95	113.11	129.34	
50.34	43.41	37.81	33.23	29.44	26.26	23.57	21.27	19.29	17.58	16.08	14.77	12.59	10.85	9.45	
28.58	33.15	38.05	43.29	48.88	54.80	61.05	67.65	74.58	81.85	89.46	97.41	114.33	132.59	152.21	
6.89	5.85	6.26	5.81	5.80	5.44	5.12	4.83	4.87	4.63	4.41	4.21	3.86	3.56	3.31	
23.07	26.58	30.32	34.31	38.54	43.01	47.72	52.67	57.86	63.30	68.98	74.90	87.46	100.99	115.49	
63.15	54.45	47.43	41.69	36.93	32.94	29.56	26.68	24.20	22.05	20.17	18.53	15.79	13.61	11.86	
25.52	29.60	33.98	38.66	43.64	48.92	54.51	60.40	66.59	73.08	79.88	86.98	102.08	118.38	135.90	
7.91	7.25	7.19	6.67	6.23	6.24	5.87	5.55	5.26	5.31	5.06	4.83	4.43	4.09	3.80	
21.53	24.80	28.30	32.02	35.97	40.14	44.54	49.16	54.01	59.08	64.38	69.90	81.63	94.26	107.79	
72.49	62.51	54.45	47.86	42.39	37.81	33.94	30.63	27.78	25.31	23.16	21.27	18.12	15.63	13.61	
23.82	27.62	31.71	36.08	40.73	45.66	50.88	56.37	62.15	68.21	74.55	81.18	95.27	110.49	126.84	
9.97	9.87	9.11	8.46	7.89	7.95	7.48	7.06	6.69	6.80	6.47	6.18	6.03	5.56	5.17	
18.46	21.26	24.26	27.45	30.83	34.40	38.17	42.14	46.29	50.64	55.18	59.92	69.97	80.79	92.39	
98.67	85.08	74.11	65.14	57.70	51.47	46.19	41.69	37.81	34.45	31.52	28.95	24.67	21.27	18.53	
20.42	23.68	27.18	30.92	34.91	39.14	43.61	48.32	53.27	58.47	63.90	69.58	81.66	94.71	108.72	
5.46	5.55	5.12	5.22	4.87	4.57	4.68	4.42	4.19	3.98	3.79	3.62	3.31	3.06	2.84	
21.53	24.80	28.30	32.02	35.97	40.14	44.54	49.16	54.01	59.08	64.38	69.90	81.63	94.26	107.79	
40.40	34.83	30.34	26.67	23.62	21.07	18.91	17.07	15.48	14.11	12.91	11.85	10.10	8.71	7.59	
23.82	27.62	31.71	36.08	40.73	45.66	50.88	56.37	62.15	68.21	74.55	81.18	95.27	110.49	126.84	
7.43	6.81	6.29	6.47	6.04	6.21	5.85	5.52	5.23	5.41	5.15	4.92	4.51	4.16	3.87	
18.46	21.26	24.26	27.45	30.83	34.40	38.17	42.14	46.29	50.64	55.18	59.92	69.97	80.79	92.39	
54.98	47.41	41.30	36.30	32.15	28.68	25.74	23.23	21.07	19.20	17.57	16.13	13.75	11.85	10.32	
20.42	23.68	27.18	30.92	34.91	39.14	43.61	48.32	53.27	58.47	63.90	69.58	81.66	94.71	108.72	
7.02	6.43	6.43	5.97	5.57	5.63	5.30	5.00	4.74	4.82	4.59	4.39	4.02	3.71	3.45	
21.53	24.80	28.30	32.02	35.97	40.14	44.54	49.16	54.01	59.08	64.38	69.90	81.63	94.26	107.79	
60.89	52.51	45.74	40.20	35.61	31.76	28.51	25.73	23.34	21.26	19.45	17.87	15.22	13.13	11.43	
23.82	27.62	31.71	36.08	40.73	45.66	50.88	56.37	62.15	68.21	74.55	81.18	95.27	110.49	126.84	
8.75	8.75	8.08	7.50	7.00	7.11	6.69	6.81	6.45	6.13	5.84	5.97	5.47	5.05	4.69	
18.46	21.26	24.26	27.45	30.83	34.40	38.17	42.14	46.29	50.64	55.18	59.92	69.97	80.79	92.39	
82.88	71.47	62.26	54.72	48.47	43.23	38.80	35.02	31.76	28.94	26.48	24.32	20.72	17.87	15.56	
20.42	23.68	27.18	30.92	34.91	39.14	43.61	48.32	53.27	58.47	63.90	69.58	81.66	94.71	108.72	

Accessibility (highlighted yellow):
 Please refer to DIN 24537-3, the stipulations of the Employer's Liability Insurance Association in instruction sheet BGI 588 and the quality assurance conditions for gratings in RAL-GZ 638 for more information on accessibility. These values assume that accessibility will be completely unimpaired if gratings are dimensioned so that the weakest point can support a point load of at least 1.5 kN with a load contact surface 200 x 200 mm in size. Deviation due to the load may be no more than 1/200 of the land width and the difference in height between neighbouring joints between loaded and unloaded floor coverings may be no more than 4 mm.

Before the blue mark:
 At a distributed actual load of 5 kN/m² the maximum deviation will be 1/200 of the span at this threshold.

Grating with smooth surface, heavy duty
Land width So 11 mm / Su 9 mm

GRP-S model

Model code	Height mm	MT mm	MW mm	Panel dimensions mm	Weight kg/m ²
S 915-38-9	15	38.35 x 38.35	28 x 28	2005 x 1005	9
				2505 x 1005	9
				2005 x 1315	9
				3005 x 1005	9
S 920-38-9	20	38.35 x 38.35	28 x 28	2005 x 1005	12
				2505 x 1005	12
				2005 x 1315	12
				3005 x 1005	12
S 925-38-9	25	38.35 x 38.35	28 x 28	2005 x 1005	15
				2505 x 1005	15
				2005 x 1315	15
				3005 x 1005	15
S 928-38-9	28	38.35 x 38.35	28 x 28	2005 x 1005	16.8
				2505 x 1005	16.8
				2005 x 1315	16.8
				3005 x 1005	16.8
S 930-38-9	30	38.35 x 38.35	28 x 28	2005 x 1005	18
				2505 x 1005	18
				2005 x 1315	18
				3005 x 1005	18
S 935-38-9	35	38.35 x 38.35	28 x 28	2005 x 1005	21
				2505 x 1005	21
				2005 x 1315	21
				3005 x 1005	21
S 938-38-9	38	38.35 x 38.35	28 x 28	2005 x 1005	23.8
				2505 x 1005	23.8
				2005 x 1315	23.8
				3005 x 1005	23.8
S 940-38-9	40	38.35 x 38.35	28 x 28	2005 x 1005	25
				2505 x 1005	25
				2005 x 1315	25
				3005 x 1005	25
S 945-38-9	45	38.35 x 38.35	28 x 28	2005 x 1005	29
				2505 x 1005	29
S 950-38-9	50	38.35 x 38.35	28 x 28	2005 x 1005	34
				2505 x 1005	34
S 955-38-9	55	38.35 x 38.35	28 x 28	2005 x 1005	39
				2505 x 1005	39
S 960-38-9	60	38.35 x 38.35	28 x 28	2005 x 1005	44
				2505 x 1005	44
S 965-38-9	65	38.35 x 38.35	28 x 28	2005 x 1005	50
				2508 x 1005	50
S 970-38-9	70	38.35 x 38.35	28 x 28	2005 x 1005	56
				2505 x 1005	56

Manufactured from high quality resin, standard colour grey, similar to Ral 7042. Other resins, colours and surfaces available on request.
MT = mesh spacing, MW = mesh width

Calculation for self contained meshes

We calculate the dimensions of self contained meshes using the following formula:

(Desired grating size minus width of upper bar support So) divided by mesh spacing = number of meshes

$$L = (n \times MT) + So + \text{clearance}$$

The resulting number of meshes is then rounded up or down to the nearest value as necessary/requested. This value is then multiplied by the mesh spacing, and added to the land width plus the clearance allowance.

Example:

Required width: 800 mm
Required length: 1300 mm
Mesh spacing: 38.35 mm
Land width: 11.0 mm
Clearance allowance: 2.0 mm

Self contained meshes / rounded down dimensions
(800-11)/38.35 = 20.57 -> selected values: 20
20 x 38.35 + 11 + 2 = 780 mm
(1300-11)/38.35 = 33.61 -> selected values: 33
33 x 38.35 + 11 + 2 = 1279 mm

Self contained meshes / rounded up dimensions
(800-11)/38.35 = 20.57 -> selected values: 21
21 x 38.35 + 11 + 2 = 818 mm
(1300-11)/38.35 = 33.61 -> selected values: 34
34 x 38.35 + 8 + 2 = 1317 mm

For more information on the mesh spacing please see DIN EN ISO 14122 part 2

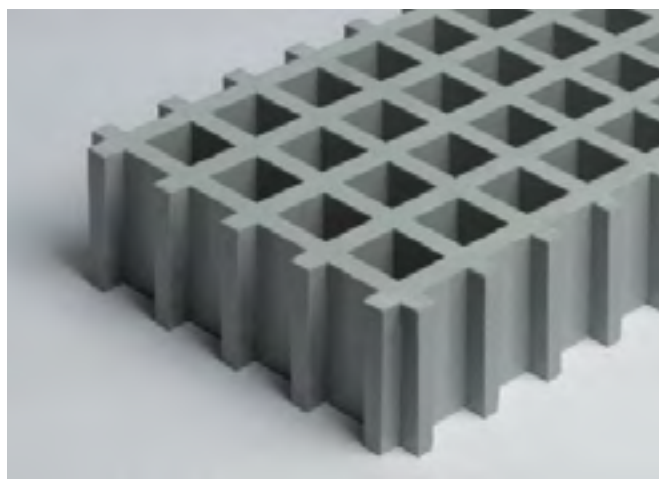
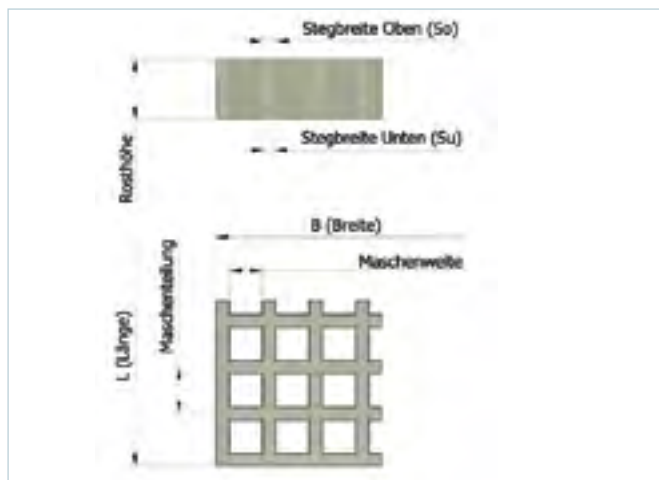

Grating with smooth surface, heavy duty
Land width So 11 mm / Su 9 mm

GRP-S model

Model code	Height mm	MT mm	MW mm	Panel dimensions mm	Weight kg/m ²
S 915-25/100-9	15	25 x 100	14 x 89	2005 x 1005 2505 x 1005	9 9
S 920-25/100-9	20	25 x 100	14 x 89	2005 x 1005 2505 x 1005	12 12
S 925-25/100-9	25	25 x 100	14 x 89	2005 x 1005 2505 x 1005	15 15
S 928-25/100-9	28	25 x 100	14 x 89	2005 x 1005 2505 x 1005	16.8 16.8
S 930-25/100-9	30	25 x 100	14 x 89	2005 x 1005 2505 x 1005	18 18
S 935-25/100-9	35	25 x 100	14 x 89	2005 x 1005 2505 x 1005	21 21
S 938-25/100-9	38	25 x 100	14 x 89	2005 x 1005 2505 x 1005	23.8 23.8
S 940-25/100-9	40	25 x 100	14 x 89	2005 x 1005 2505 x 1005	25 25
S 945-25/100-9	45	25 x 100	14 x 89	2005 x 1005 2505 x 1005	29 29
S 950-25/100-9	50	25 x 100	14 x 89	2005 x 1005 2505 x 1005	34 34
S 955-25/100-9	55	25 x 100	14 x 89	2005 x 1005 2505 x 1005	39 39
S 960-25/100-9	60	25 x 100	14 x 89	2005 x 1005 2505 x 1005	44 44

Manufactured from high quality resin, standard colour grey, similar to Ral 7042. Other resins, colours and surfaces available on request.
MT = mesh spacing, MW = mesh width

Grating with smooth surface, heavy duty
Land width So 10 mm / Su 8 mm

GRP-S model

Model code	Height mm	MT mm	MW mm	Panel dimensions mm	Weight kg/m ²
S 835-76-8	35	76.7 x 76.7	65 x 65	2468 x 1005	11

Manufactured from high quality resin, standard colour grey, similar to Ral 7042. Other resins, colours and surfaces available on request.
MT = mesh spacing, MW = mesh width

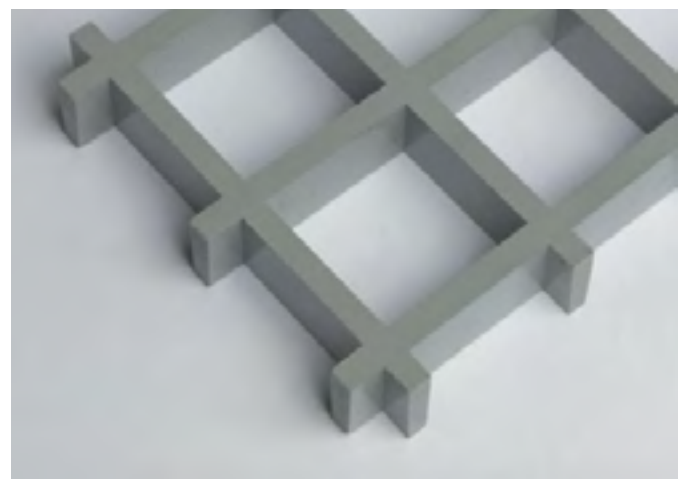
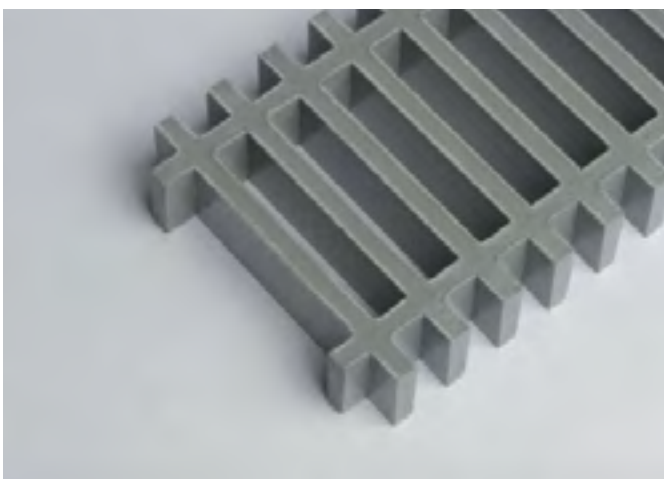
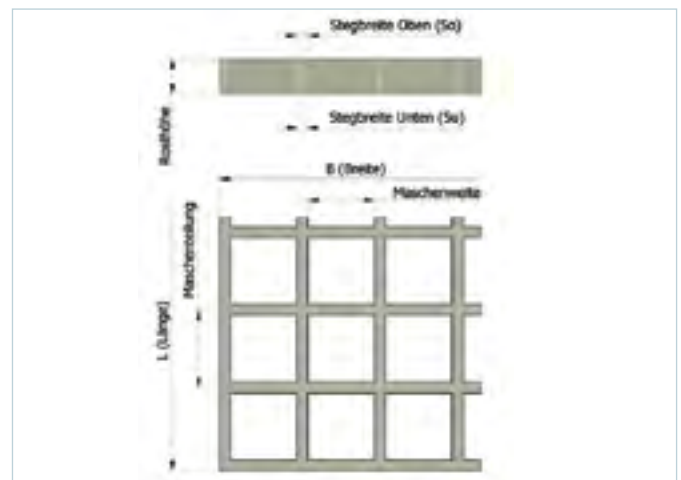

Gratings in accordance with DIN 24537-3

GRP-S model

Model code	Grating height	Mesh spacing	kg/m ²		Span mm						
					200	300	400	450	500	550	600
GRP-S 915-38-9	15 mm	38 x 38 mm	9	Fp	9.97	4.98	4.13	3.88	3.40	3.29	2.96
				f1	4.51	9.92	17.14	21.42	26.16	31.34	36.98
				Fv	158.68	70.53	39.67	31.35	25.39	20.98	17.63
				f	4.51	10.15	18.04	22.83	28.19	34.11	40.59
GRP-S 920-38-9	20 mm	38 x 38 mm	12	Fp	17.72	8.86	6.62	5.67	4.97	4.89	4.40
				f1	3.38	7.44	12.85	16.07	19.62	23.51	27.74
				Fv	282.11	125.38	70.53	55.72	45.14	37.30	31.35
				f	3.38	7.61	13.53	17.12	21.14	25.58	30.44
GRP-S 925-38-9	25 mm	38 x 38 mm	15	Fp	27.68	13.84	9.23	7.91	6.92	6.90	6.21
				f1	2.71	5.95	10.28	12.85	15.69	18.81	22.19
				Fv	440.79	195.91	110.20	87.07	70.53	58.29	48.98
				f	2.71	6.09	10.82	13.70	16.91	20.46	24.35
GRP-S 928-38-9	28 mm	38 x 38 mm	16.8	Fp	34.72	17.36	11.57	9.92	8.68	7.72	7.79
				f1	2.42	5.32	9.18	11.48	14.01	16.79	19.81
				Fv	552.93	245.75	138.23	109.22	88.47	73.11	61.44
				f	2.42	5.44	9.66	12.23	15.10	18.27	21.74
GRP-S 930-38-9	30 mm	38 x 38 mm	18	Fp	39.86	19.93	13.29	11.39	9.97	8.86	8.94
				f1	2.25	4.96	8.57	10.71	13.08	15.67	18.49
				Fv	634.74	282.11	158.68	125.38	101.56	83.93	70.53
				f	2.25	5.07	9.02	11.42	14.09	17.05	20.29
GRP-S 935-38-9	35 mm	38 x 38 mm	21	Fp	54.26	27.13	18.09	15.50	13.56	12.06	10.85
				f1	1.93	4.25	7.34	9.18	11.21	13.43	15.85
				Fv	863.95	383.98	215.99	170.66	138.23	114.24	95.99
				f	1.93	4.35	7.73	9.78	12.08	14.62	17.40
GRP-S 938-38-9	38 mm	38 x 38 mm	23.8	Fp	63.96	31.98	21.32	18.27	15.99	14.21	12.79
				f1	1.78	3.92	6.76	8.46	10.33	12.37	14.60
				Fv	1018.40	452.62	254.60	201.17	162.94	134.66	113.16
				f	1.78	4.01	7.12	9.01	11.13	13.46	16.02

Legend

Fv = load values for equally distributed load in kN/m²

f = deviation in mm at load Fv

Fp = load values for a centrally placed point load in kN and a contact area of 200 x 200 mm

f1 = deviation in mm at point load Fp

1 kN = 1000 N ~ 100 kg

Example

The values in the table indicate the max. thresholds. Because of the linear behaviour of the material, these values can be used to calculate any necessary status according to requirements. For this example we will use grating model GRP-S 938-38-9 with a span of 700 mm.

Max. deviation + max. point load x required point load = corresponding deviation

19.58 mm ÷ 10.66 kN x 1.5 kN = 2.755 mm

Multiplication factors (supporting rod spacing 25 mm)

Mesh spacing	Distributed load capacity	Point load
25 x 100	1.52	1.33

Safety factor
to breaking limit: 3.0

Deterioration coefficient
at deviation: 1.3

The initial safety value in the table is 3.0 in compliance with the breaking and deviation deterioration coefficients laid down in DIN 24537-3. The values in the table do not apply if different forces are used!

Span mm		700	750	800	850	900	950	1000	1050	1100	1150	1200	1300	1400	1500
650	700	750	800	850	900	950	1000	1050	1100	1150	1200	1300	1400	1500	
2.69	2.46	2.28	2.11	1.97	1.85	1.74	1.64	0.67	0.63	0.60	0.58	0.53	0.49	0.45	
43.07	49.61	56.60	64.04	71.93	80.28	89.07	98.32	108.01	118.16	128.76	139.81	163.26	188.51	215.57	
15.02	12.95	11.28	9.92	8.79	7.84	7.03	6.35	5.76	5.25	4.80	4.41	3.76	3.24	2.82	
47.64	55.25	63.42	72.16	81.46	91.33	101.75	112.75	124.30	136.42	149.11	162.36	190.54	220.98	253.68	
4.39	4.02	4.04	3.76	3.51	3.29	3.09	2.92	2.77	2.63	2.50	2.39	2.19	2.02	0.81	
32.30	37.21	42.45	48.03	53.95	60.21	66.80	73.74	81.01	88.62	96.57	104.85	122.44	141.39	161.68	
26.71	23.03	20.06	17.63	15.62	13.93	12.50	11.28	10.24	9.33	8.53	7.84	6.68	5.76	5.02	
35.73	41.43	47.57	54.12	61.09	68.49	76.32	84.56	93.23	102.32	111.83	121.77	142.91	165.74	190.26	
6.25	5.73	5.80	5.39	5.03	5.14	4.83	4.56	4.32	4.11	3.91	3.73	3.42	3.16	2.93	
25.84	29.77	33.96	38.42	43.16	48.17	53.44	58.99	64.81	70.90	77.25	83.88	97.95	113.11	129.34	
41.73	35.98	31.35	27.55	24.40	21.77	19.54	17.63	15.99	14.57	13.33	12.24	10.43	9.00	7.84	
28.58	33.15	38.05	43.29	48.88	54.80	61.05	67.65	74.58	81.85	89.46	97.41	114.33	132.59	152.21	
7.08	7.19	6.64	6.16	6.31	5.92	5.57	5.26	5.42	5.15	4.91	4.68	4.29	3.96	3.68	
23.07	26.58	30.32	34.31	38.54	43.01	47.72	52.67	57.86	63.30	68.98	74.90	87.46	100.99	115.49	
52.35	45.14	39.32	34.56	30.61	27.31	24.51	22.12	20.06	18.28	16.72	15.36	13.09	11.28	9.83	
25.52	29.60	33.98	38.66	43.64	48.92	54.51	60.40	66.59	73.08	79.88	86.98	102.08	118.38	135.90	
8.12	7.45	7.62	7.07	6.60	6.79	6.39	6.04	5.72	5.92	5.63	5.38	4.93	4.55	4.23	
21.53	24.80	28.30	32.02	35.97	40.14	44.54	49.16	54.01	59.08	64.38	69.90	81.63	94.26	107.79	
60.09	51.82	45.14	39.67	35.14	31.35	28.13	25.39	23.03	20.98	19.20	17.63	15.02	12.95	11.28	
23.82	27.62	31.71	36.08	40.73	45.66	50.88	56.37	62.15	68.21	74.55	81.18	95.27	110.49	126.84	
9.86	10.14	9.36	8.69	8.11	8.42	7.93	7.49	7.09	7.40	7.04	6.72	6.71	6.19	5.75	
18.46	21.26	24.26	27.45	30.83	34.40	38.17	42.14	46.29	50.64	55.18	59.92	69.97	80.79	92.39	
81.79	70.53	61.44	54.00	47.83	42.66	38.29	34.56	31.35	28.56	26.13	24.00	20.45	17.63	15.36	
20.42	23.68	27.18	30.92	34.91	39.14	43.61	48.32	53.27	58.47	63.90	69.58	81.66	94.71	108.72	
11.63	10.66	11.03	10.24	9.56	8.96	9.35	8.83	8.36	7.94	7.57	7.93	7.26	7.30	6.78	
17.00	19.58	22.34	25.28	28.39	31.69	35.16	38.81	42.64	46.64	50.83	55.19	64.44	74.41	85.09	
96.42	83.13	72.42	63.65	56.38	50.29	45.14	40.74	36.95	33.67	30.80	28.29	24.10	20.78	18.10	
18.80	21.81	25.03	28.48	32.16	36.05	40.17	44.51	49.07	53.85	58.86	64.09	75.21	87.23	100.14	

Accessibility (highlighted yellow):
 Please refer to DIN 24537-3, the stipulations of the Employer's Liability Insurance Association in instruction sheet BGI 588 and the quality assurance conditions for gratings in RAL-GZ 638 for more information on accessibility. These values assume that accessibility will be completely unimpaired if gratings are dimensioned so that the weakest point can support a point load of at least 1.5 kN with a load contact surface 200 x 200 mm in size. Deviation due to the load may be no more than 1/200 of the land width and the difference in height between neighbouring joints between loaded and unloaded floor coverings may be no more than 4 mm.

Before the blue mark:
 At a distributed actual load of 5 kN/m² the maximum deviation will be 1/200 of the span at this threshold.

Gratings in accordance with DIN 24537-3

GRP-S model

Model code	Grating height	Mesh spacing	kg/m ²		Span mm						
					200	300	400	450	500	550	600
GRP-S 940-38-9	40 mm	38 x 38 mm	25	Fp	70.86	35.43	23.62	20.25	17.72	15.75	14.17
				f1	1.69	3.72	6.43	8.03	9.81	11.75	13.87
				Fv	1128.42	501.52	282.11	222.90	180.55	149.21	125.38
				f	1.69	3.81	6.76	8.56	10.57	12.79	15.22
GRP-S 945-38-9	45 mm	38 x 38 mm	29	Fp	89.69	44.84	29.90	25.63	22.42	19.93	17.94
				f1	1.50	3.31	5.71	7.14	8.72	10.45	12.33
				Fv	1428.16	634.74	357.04	282.11	228.51	188.85	158.68
				f	1.50	3.38	6.01	7.61	9.40	11.37	13.53
GRP-S 950-38-9	50 mm	38 x 38 mm	34	Fp	110.73	55.36	36.91	31.64	27.68	24.61	22.15
				f1	1.45	3.19	5.51	6.89	8.41	10.08	11.89
				Fv	1763.16	783.63	440.79	348.28	282.11	233.14	195.91
				f	1.45	3.26	5.80	7.34	9.06	10.97	13.05
GRP-S 955-38-9	55 mm	38 x 38 mm	39	Fp	133.98	66.99	44.66	38.28	33.49	29.77	26.80
				f1	1.23	2.71	4.67	5.84	7.13	8.55	10.09
				Fv	2133.42	948.19	533.36	421.42	341.35	282.11	237.05
				f	1.23	2.77	4.92	6.23	7.69	9.30	11.07
GRP-S 960-38-9	60 mm	38 x 38 mm	44	Fp	159.45	79.72	53.15	45.56	39.86	35.43	31.89
				f1	1.21	2.66	4.59	5.74	7.01	8.40	9.91
				Fv	2538.95	1128.42	634.74	501.52	406.23	335.73	282.11
				f	1.21	2.72	4.83	6.12	7.55	9.14	10.88
GRP-S 965-38-9	65 mm	38 x 38 mm	50	Fp	187.13	93.56	62.38	53.46	46.78	41.58	37.43
				f1	1.04	2.29	3.95	4.94	6.04	7.23	8.53
				Fv	2979.74	1324.33	744.93	588.59	476.76	394.01	331.08
				f	1.04	2.34	4.16	5.27	6.50	7.87	9.37
GRP-S 970-38-9	70 mm	38 x 38 mm	56	Fp	217.02	108.51	72.34	62.01	54.26	48.23	43.40
				f1	0.97	2.13	3.67	4.59	5.61	6.72	7.92
				Fv	3455.79	1535.91	863.95	682.63	552.93	456.96	383.98
				f	0.97	2.17	3.87	4.89	6.04	7.31	8.70
GRP-S 935-76-9	35 mm	76 x 76 mm	11	Fp	36.98	18.49	12.33	10.56	9.24	8.22	7.40
				f1	1.93	4.25	7.34	9.18	11.21	13.43	15.85
				Fv	431.97	191.99	107.99	85.33	69.12	57.12	48.00
				f	1.93	4.35	7.73	9.78	12.08	14.62	17.40

Legend

Fv = load values for equally distributed load in kN/m²

f = deviation in mm at load Fv

Fp = load values for a centrally placed point load in kN and a contact area of 200 x 200 mm

f1 = deviation in mm at point load Fp

1 kN = 1000 N ~ 100 kg

Example

The values in the table indicate the max. thresholds. Because of the linear behaviour of the material, these values can be used to calculate any necessary status according to requirements. For this example we will use grating model GRP-S 935-76-9 with a span of 700 mm.

Max. deviation + max. point load x required point load = corresponding deviation

21.26 mm ÷ 7.26 kN x 1.5 kN = 4.393 mm

Multiplication factors (supporting rod spacing 25 mm)

Mesh spacing	Distributed load capacity	Point load
25 x 100	1.52	1.33

(25 x 100 mm mesh spacing up to maximum of 60 mm grating height)

Safety factor
to breaking limit: 3.0

Deterioration coefficient
at deviation: 1.3

The initial safety value in the table is 3.0 in compliance with the breaking and deviation deterioration coefficients laid down in DIN 24537-3. The values in the table do not apply if different forces are used!

Span mm	Span mm														
	650	700	750	800	850	900	950	1000	1050	1100	1150	1200	1300	1400	1500
12.88	11.81	10.90	10.12	10.59	9.93	9.35	8.83	9.26	8.80	8.38	8.00	8.05	7.43	7.51	
16.15	18.60	21.22	24.02	26.97	30.10	33.40	36.87	40.50	44.31	48.28	52.43	61.22	70.69	80.84	
106.83	92.12	80.24	70.53	62.47	55.72	50.01	45.14	40.94	37.30	34.13	31.35	26.71	23.03	20.06	
17.86	20.72	23.78	27.06	30.55	34.25	38.16	42.28	46.61	51.16	55.92	60.88	71.45	82.87	95.13	
16.31	14.95	13.80	12.81	13.41	12.57	11.83	11.17	10.58	10.05	10.61	10.13	9.28	9.40	8.73	
14.36	16.54	18.87	21.35	23.98	26.76	29.69	32.77	36.00	39.39	42.92	46.60	54.42	62.84	71.86	
135.21	116.58	101.56	89.26	79.07	70.53	63.30	57.13	51.82	47.21	43.20	39.67	33.80	29.15	25.39	
15.88	18.42	21.14	24.05	27.15	30.44	33.92	37.58	41.43	45.47	49.70	54.12	63.51	73.66	84.56	
20.13	18.45	17.03	15.82	14.76	13.84	13.03	13.79	13.07	12.41	11.82	11.28	10.34	10.58	10.78	
13.85	15.95	18.20	20.60	23.13	25.82	28.65	31.62	34.74	38.00	41.41	44.96	52.50	60.63	69.33	
166.93	143.93	125.38	110.20	97.61	87.07	78.15	70.53	63.97	58.29	53.33	48.98	41.73	35.98	31.35	
15.32	17.77	20.40	23.21	26.20	29.37	32.72	36.26	39.98	43.87	47.95	52.21	61.28	71.07	81.58	
24.36	22.33	20.61	19.14	17.86	16.75	15.76	14.89	15.81	15.02	14.30	13.65	12.52	12.80	11.89	
11.75	13.53	15.44	17.47	19.62	21.89	24.29	26.81	29.46	32.23	35.12	38.13	44.52	51.41	58.79	
201.98	174.16	151.71	133.34	118.11	105.35	94.56	85.34	77.40	70.53	64.53	59.26	50.50	43.54	37.93	
12.99	15.07	17.30	19.68	22.22	24.91	27.75	30.75	33.90	37.21	40.67	44.28	51.97	60.27	69.19	
28.99	26.57	24.53	22.78	21.26	19.93	18.76	17.72	16.78	15.94	17.02	16.25	14.90	13.75	14.15	
11.54	13.30	15.17	17.16	19.28	21.51	23.87	26.35	28.95	31.67	34.51	37.47	43.75	50.52	57.77	
240.37	207.26	180.55	158.68	140.56	125.38	112.53	101.56	92.12	83.93	76.79	70.53	60.09	51.82	45.14	
12.77	14.81	17.00	19.34	21.83	24.48	27.27	30.22	33.31	36.56	39.96	43.51	51.07	59.22	67.99	
34.02	31.19	28.79	26.73	24.95	23.39	22.01	20.79	19.70	18.71	17.82	17.01	15.59	16.14	14.98	
9.94	11.45	13.06	14.78	16.60	18.53	20.55	22.69	24.93	27.27	29.71	32.26	37.67	43.50	49.75	
282.11	243.24	211.89	186.23	164.97	147.15	132.07	119.19	108.11	98.50	90.12	82.77	70.53	60.81	52.97	
10.99	12.75	14.64	16.65	18.80	21.08	23.48	26.02	28.69	31.48	34.41	37.47	43.97	51.00	58.54	
39.46	36.17	33.39	31.00	28.94	27.13	25.53	24.11	22.84	21.70	20.67	19.73	18.09	18.71	17.38	
9.23	10.63	12.13	13.72	15.41	17.20	19.09	21.07	23.15	25.32	27.59	29.96	34.98	40.40	46.19	
327.18	282.11	245.75	215.99	191.32	170.66	153.17	138.23	125.38	114.24	104.52	95.99	81.79	70.53	61.44	
10.21	11.84	13.59	15.46	17.46	19.57	21.80	24.16	26.64	29.23	31.95	34.79	40.83	47.35	54.36	
7.92	7.26	6.70	6.22	6.68	6.26	6.67	6.30	5.97	5.67	6.02	5.75	5.27	4.86	4.52	
18.46	21.26	24.26	27.45	30.83	34.40	38.17	42.14	46.29	50.64	55.18	59.92	69.97	80.79	92.39	
40.90	35.26	30.72	27.00	23.92	21.33	19.15	17.28	15.67	14.28	13.07	12.00	10.22	8.82	7.68	
20.42	23.68	27.18	30.92	34.91	39.14	43.61	48.32	53.27	58.47	63.90	69.58	81.66	94.71	108.72	

Accessibility (highlighted yellow):
 Please refer to DIN 24537-3, the stipulations of the Employer's Liability Insurance Association in instruction sheet BGI 588 and the quality assurance conditions for gratings in RAL-GZ 638 for more information on accessibility. These values assume that accessibility will be completely unimpaired if gratings are dimensioned so that the weakest point can support a point load of at least 1.5 kN with a load contact surface 200 x 200 mm in size. Deviation due to the load may be no more than 1/200 of the land width and the difference in height between neighbouring joints between loaded and unloaded floor coverings may be no more than 4 mm.

Before the blue mark:
 At a distributed actual load of 5 kN/m² the maximum deviation will be 1/200 of the span at this threshold.

GRP stairtreads are supplied with a solid, sanded and black coloured nosing in widths 617 mm, 807 mm, 998 mm and 1227 mm as standard. We can guarantee solid meshes for tread depths of 236 mm, 274 mm and 312 mm. We can also provide different dimensions on request; please note that this may result in open edges. Fastening opportunities (end meshes) should also be taken into consideration.

The solid, sanded and black coloured nosing shows up its leading edge particularly clearly, contributing significantly to safety.

Lichtgitter GRP stairtreads with solid, sanded and black coloured nosing without end plate.

As standard, GRP stairtreads are fitted on supports provided by the others and screwed in with the direct joint B 638K. Please consult the table (page 33) for fastening points on the support bracket. The building contractor must provide a support in the tread area for stairtreads from 807 mm in width.

Substructure for stairs (extract from DIN EN 14122-3)
The tread g and rise h must comply with the following equation: $600 \leq g + 2 h \leq 660$.

The undercut of the stairtread or the platform must be $r \geq 10$ mm. The length of the platform l must be at least 800 mm and be equal to or larger than the solid centre width of the stair. The pitch of a staircase must be constant, if possible. If it is not possible for the pitch to be constant, the pitch may decrease by a maximum of 15% between the exit level and the first stair.

The stairs must be capable of bearing the following loads on their nosing:

- 1.5 kN point load distributed over an area of 100 x 100 mm on its nosing in the middle of the stair for a solid centre width $w < 1200$ mm
- 1.5 kN point load at any one time distributed over an area of 100 x 100 mm at 600 mm intervals from the nosing for a solid centre width $w \geq 1200$ mm.

The deflection under load between the frame and stairtread may be no greater than 1/300 of the span, to a maximum of 6.0 mm.

- | | |
|--------------------|----------------------|
| H staircase height | r undercut |
| g tread | a angle of pitch |
| e headroom | w solid centre width |
| h rise | p pitch line |
| l platform length | c clearance |



Note
See the table on page 33 for dimensions

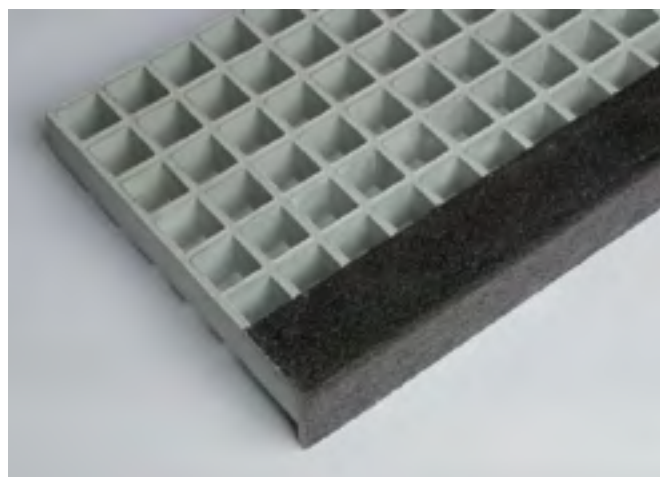
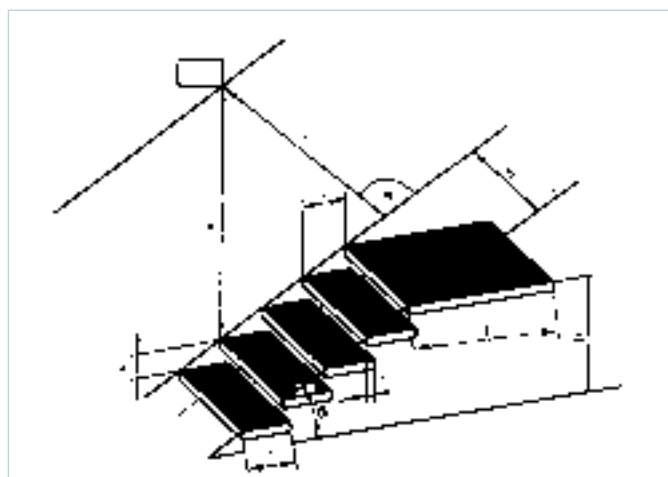

Lichtgitter GRP stairtreads with a solid, sanded and black coloured nosing and end plate made from a GRP bracket.

We can also supply GRP support brackets measuring 75 x 75 x 8 mm for stairtreads with holes on the side on request. Please see the table below for the dimensions of the holes for screwing to the side plates. Because this type of stairtread is self-supporting across the span (solid centre width), the nosing is made from a GRP support bracket in order to fulfil the structural requirements laid down in DIN EN 14122-3. The design of the GRP bracket depends on the width of the stairtread and is constructed in line with structural requirements.

When screwing the GRP support bracket to the stair stringers, ensure that the GRP support bracket is tight on the substructure. Before screwing the stairtread in, check whether you will need to be able to move the GRP support bracket that has been screwed in. You could also use spacers to avoid damaging the GRP support bracket.

The brackets which can be screwed in to serve as a support for the GRP stairtreads are available in galvanised steel or stainless steel.

Our safety tread is a simple, cost-effective stair covering made from GRP, designed to be added to stairs to make them safer. The sanded covering has been designed for concrete, metal and wooden stairs and is easy to fit. The safety tread is mainly used in areas where slippery smooth surfaces pose a threat. The bright marking of the yellow coloured nosing increases safety.

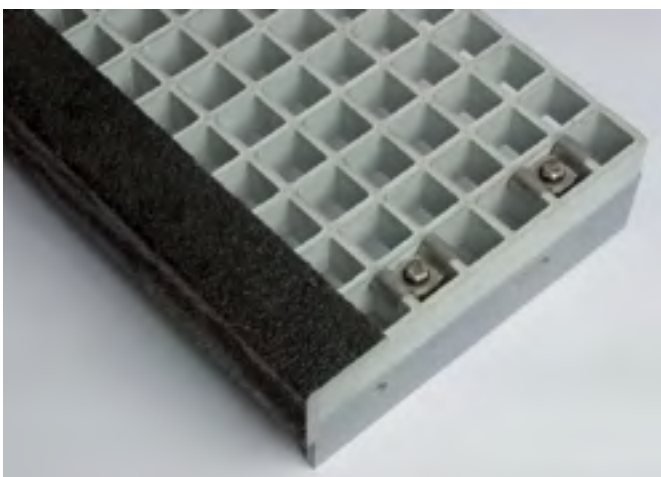
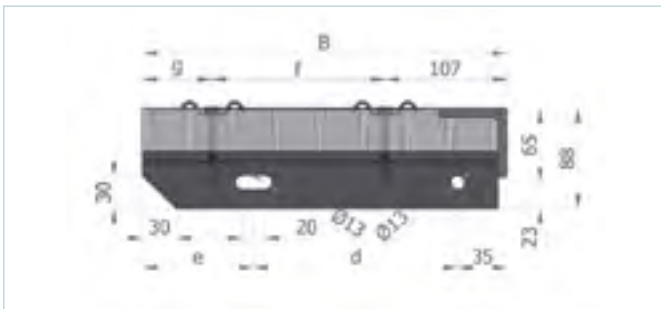
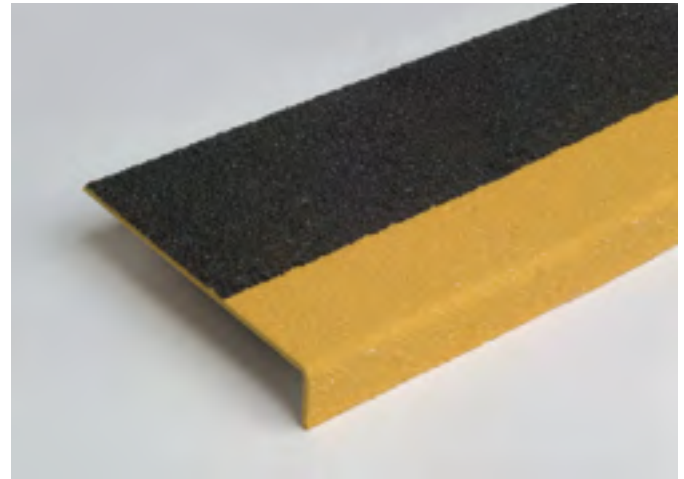

GRP grating stairs

Model code	Width B	Length L	d	e	f	g
K 538-38-5	244	617	120	89	76	61
		807				
		998				
		1227				
K 538-38-5	282	617	150	97	114	61
		807				
		998				
		1227				
K 538-38-6	320	617	180	106	152	62
		807				
		998				
		1227				

Concave – model code: GRP-K

A concave surface is taken to mean the surface of the web which curves inwards during the thermosetting process.

The web edges arrived at by this process ensure good anti-slip properties. This surface achieves anti-slip quality class R 13 according to BGR 181.

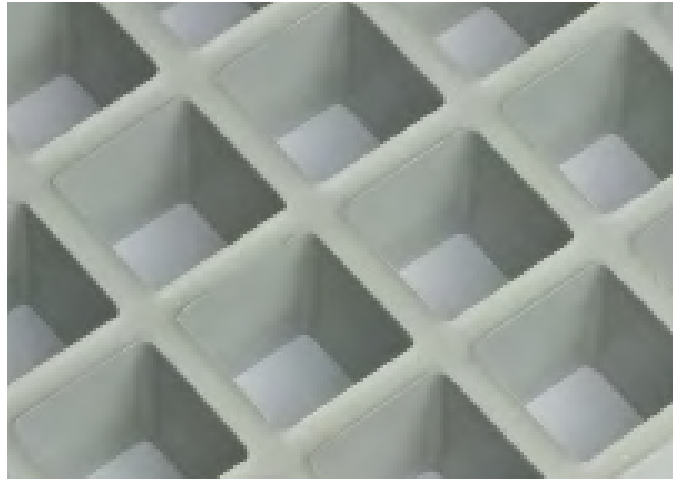
**Smooth – model code: GRP-G**

The concave surface of the GRP grating is smoothed off after the thermosetting process. This process provides a level surface which can be sealed at a later point.

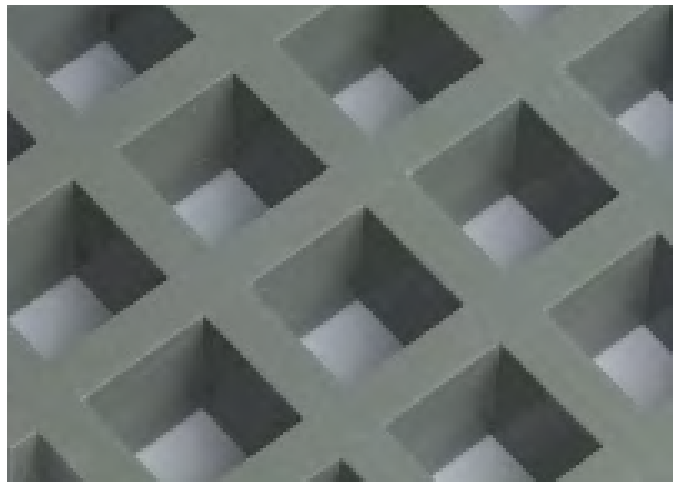
**Sanded – model code GRP-BK**

GRP gratings can also be provided with a sanded surface, achieving higher anti-slip quality classes.

The sanded surface is applied to the smoothed surface together with a resin. There is a choice of coarse corundum sanding or a smoother sanded surface with quartz.

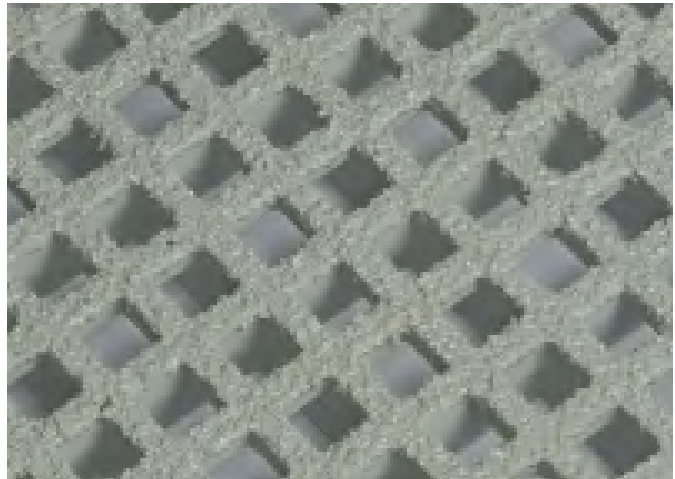
**Sanded with corundum – model code GRP-BKO**

Corundum sanding is a sanded surface with a sand grain size between 0.5 – 1.0 mm. This surface achieves anti-slip quality class R 13 making it popular for outdoor use.

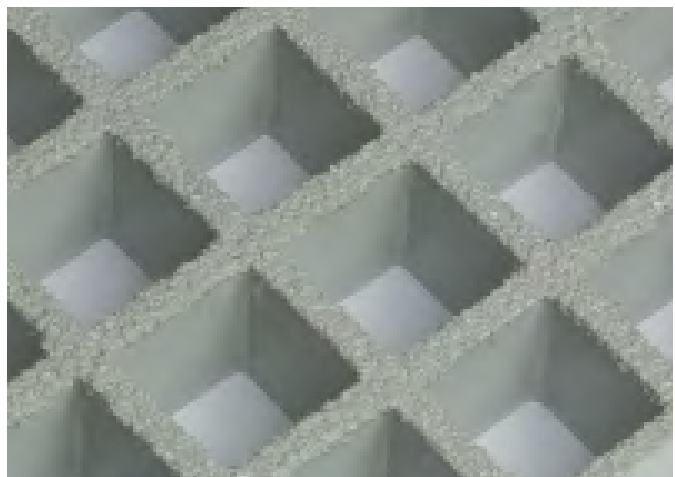

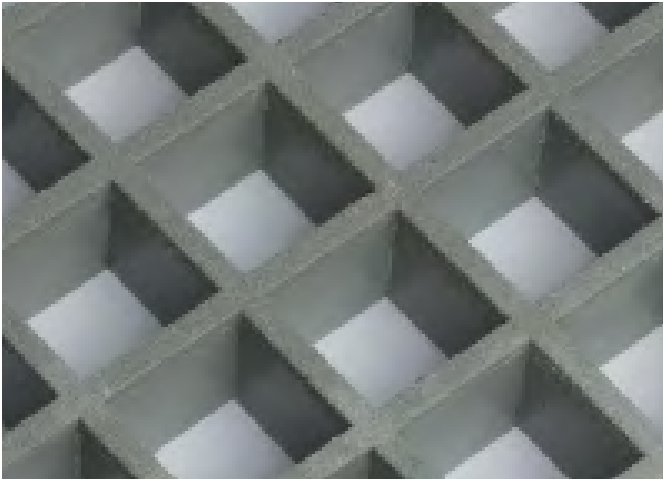

Sanded with quartz – model code GRP-BQ
Quartz sanding uses a sand grain size between 0.1 – 0.4 mm. The use of fine quartz sand grains make these gratings suitable for barefoot use and helps them achieve anti-slip quality class R 12.

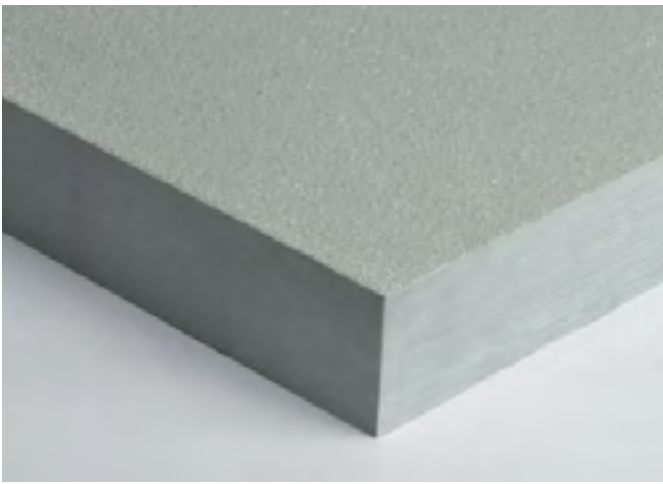

Solid – model code GRP-Solid
To produce gratings with a solid surface we laminate a GRP panel. The majority of the panels are sanded.

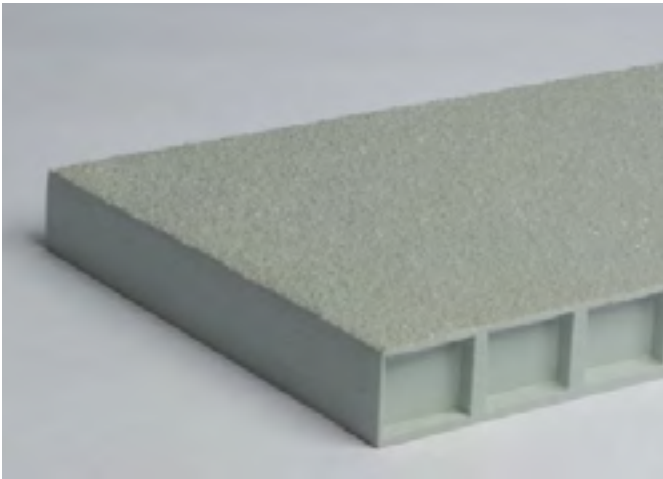

Sandwich panel – model code: GRP-Sandwich
A GRP grating which is solid on both sides. A GRP panel is laminated on both the top and the bottom. The surface can be sanded to prevent slipping. Such flooring is especially good in areas if you need close tolerances for flatness.

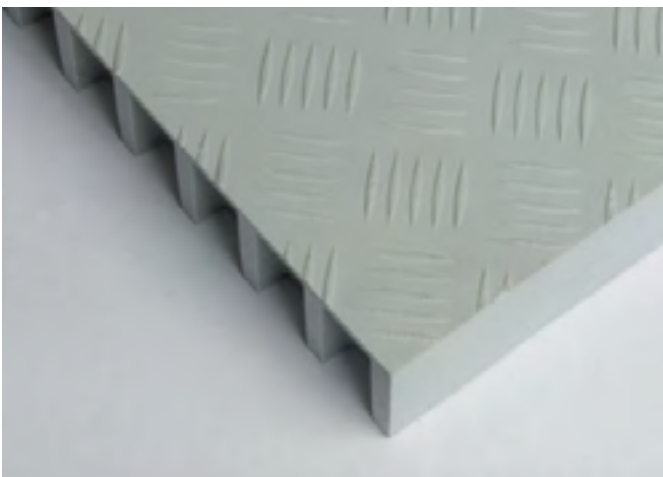

Chequered plate effect – model code: GRP-Chequered Plate
This is another solid GRP grating variant. A so-called chequered plate effect is used instead of a sanded GRP panel.

Conductive GRP gratings

The surface resistance of parts which are used in explosive areas and can become electrically charged may not exceed 1 GΩ. The Rhineland Technical Inspection Authority tested whether our conductive GRP gratings complied with the requirements laid down in EN standard 60079-0 and concluded that our grating stays within the required limits and that the product can be used without hesitation.

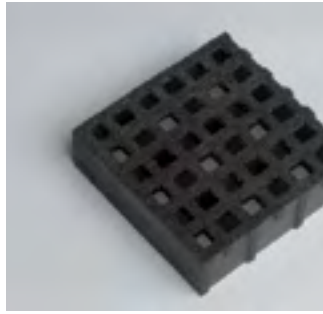
**GRP safety flooring**

These are composed of a GRP grating with a GRP panel laminated on one or both sides. These can be made with a variety of surfaces (see page 35). GRP safety flooring is used as covering for cavities, manholes, gutters and drains.

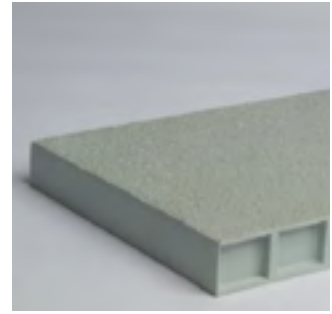
**Swimming pool gratings:**

A particularly fine-grain sanding with quartz makes it possible to walk on these GRP gratings barefoot.

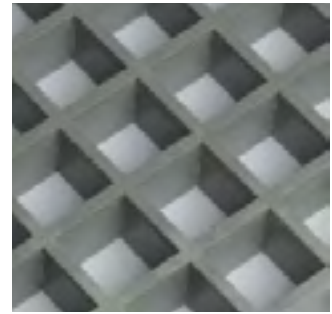
**Phenolic gratings**

Phenolic gratings are known for their especially good flammability rating, high levels of temperature resistance and low levels of smoke emission.

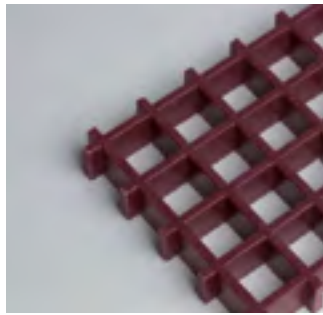
**Façade cladding**

The flexibility and special material characteristics of the GRP grating also make them perfectly suited for use as façade cladding and offer visual highlights.

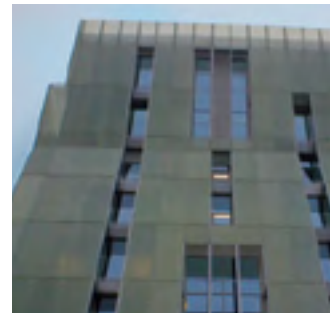
**Food grade gratings**

The resin used for food grade GRP gratings was specially developed for use in the food industry.

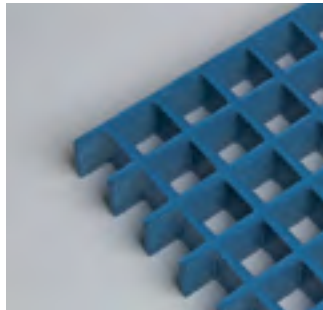
**Railing infills and fence elements**

Our robust and weather-resistant GRP gratings are optimally suited for use as railing infills and fence elements in conjunction with GRP post profiles.

**Transparent gratings**

No pigmentation is added to transparent GRP gratings during production. The resin gives the grating a slight green tint, but the grating still lets light through.

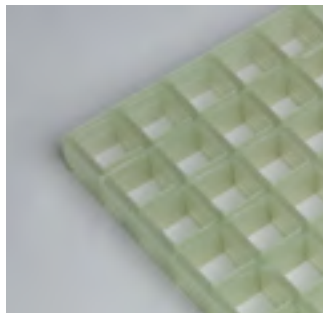
**Lawn gratings**

GRP gratings are a suitable choice both in appearance and functionality for securing grassy areas, car parks or thoroughfares.

**Translucent gratings**

In contrast to the transparent GRP gratings, small amounts of colour pigment are used during the production of translucent gratings. The gratings remain translucent but have a hint of colour.

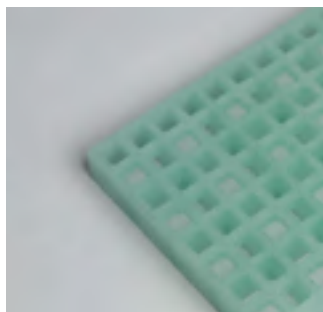

Lichtgitter GRP gratings are often used in industries which require the gratings to be resistant to corrosive elements. The medium and its concentration, temperature and the duration of exposure have a major influence on the resistance.

Chemical resistance table Lichtgitter GRP gratings (GRP-K/GRP-BK)

Chemical environment	Isophthalic resin % concentration	Isophthalic resin Temp °C	Vinyl ester resin % concentration	Vinyl ester resin Temp °C
Aluminium salts	All	70	All	90
Ammonium bicarbonate	15	50	All	50
Ammonium chloride	All	70	All	85
Ammonium nitrate	All	70	All	85
Acetone	N/R	N/R	100	25
Benzoic acid	All	65	All	90
Benzoin	N/R	N/R	100	60
Prussic acid/hydrocyanic acid	All	65	All	85
Lead acetate / sugar of lead	All	75	All	90
Lead chloride	All	60	All	90
Lead nitrate	All	65	All	90
Hydrobromic acid	50	50	50	50
Calcium salts	All	65	All	90
Calcium hypochlorite	All	65	All	85
Chlorine dioxide	N/R	N/R	All	60
Chlorine water	All	25	All	50
Chromic acid	10	60	10	85
Distilled water	100	75	100	90
Iron salts	100	65	100	85
Vinegar	100	75	100	90
Acetic acid	50	50	50	85
Ethyl acetate, ethyl ether	N/R	N/R	N/R	N/R
Ethyl alcohol/ethanol	50	25	50	30
Ferric salt, iron (III) salt	All	65	All	85
Glycerine	100	65	100	90
Carbamide, urea, carbonyl diamide	All	50	All	60
Heptane	100	40	100	50
Sal volatile/Ammonium carbonate	N/R	N/R	All	65
Lunar caustic/silver nitrate	100	65	100	85
Potash	All	65	All	85
Calcium nitrate	All	85	All	90
Calcium hydroxide	25	65	35	85
Carbon dioxide/Carbolic acid/coal gas	All	50	All	85
Copper cyanide	All	50	All	85
Cuprous salt	All	65	All	85
Magnesium salt	All	65	All	85
Maleic acid	100	65	100	85
Salt water	All	75	All	90
Lactic acid/hydroxypropionic acid	All	75	All	90
Sodium salt	All	25	All	40
Nickel salt	All	75	All	90
Perchloric acid	N/R	N/R	30	30
Phosphoric acid	100	50	100	90
Mercury chloride	100	65	100	85
Ammonium hydroxide	28	N/R	28	38
Mitric acid	20	25	20	40
Hydrochloric acid	37	25	37	35
Sulphuric acid	50	N/R	50	85
Sulphuric acid	25	25	25	90
Sodium hypochlorite	N/R	N/R	10	65
Styrol, styrene, phenylethylene	N/R	N/R	N/R	N/R
Tetrachloromethane/carbon tetrachloride	100	25	100	60
Trisodium phosphate	N/R	N/R	All	65
Hypochlorous acid	20	30	20	65
Hydrogen peroxide, hydrogen superoxide	10	25	30	50
Tartaric acid	All	75	All	90
Zinc salt	100	65	100	85
Tin chloride	All	70	All	90
Citric acid	All	65	All	85

All = valid for all concentrations
N/R = not recommended

Note

Our written and verbal advice is correct to the best of our knowledge, but should not be considered a binding guarantee including as regards any third party industrial property rights. You should always test the products that we deliver to see whether they are suitable for the processes and purposes which they are intended for. We are unable to monitor the application, use and processing of the products. This is entirely your responsibility.

GRP gratings are often used as floor coverings. The German Institute for Work Safety has developed criteria for determining how good a grating is at preventing slips. Information sheet BGR 181, "Flooring in working areas with the risk of slipping", contains

- The working areas with increased skid risk,
- The implementation of tests to determine the criteria for skid prevention and
- The classification of the floor coverings tested

Our standard Lichtgitter GRP grating GRP-K achieved the highest anti-slip quality class possible: R 13.

Other anti-slip test results (test certificates available) can be seen in the table opposite.

Test for Anti-slip characteristics

Lichtgitter provided the institute with GRP gratings to be tested. Test result certificates are available and the results published by the Institute at the same time. We are entitled to display the BG sign on our products.

The floor coverings for workrooms and working areas are placed in different quality classes depending on the likelihood of a slip occurring.

"The median angle of a number of values is an important factor in deciding in which of the five quality classes the floor covering will be placed. The quality class is a measure of the effectiveness of the anti-slip properties of the floor covering; coverings in quality class R9 satisfy the lowest demands while those in quality class R 13 fulfil the highest demands. Which quality class is assigned to which angle range can be seen in the table opposite".

All of our tested products were certified as having a displacement area of V 10.

Walkways with a slope between 6° and 20°

We recommend using standard gratings for walkways on conveying machinery or similar equipment which have an incline of up to 6°. Walkways inclined between 6° and 10° should be equipped with anti-slip gratings. For inclines between 10° and 20°, gratings with toe plates across the entire walking area are necessary. If the incline exceeds 20°, it should be bridged with stairs.

For more advice please see ZH 1/640 series "interior StBG transportation routes".

Model code	Surface	Quality class	Displacement area
K 630-20-6	concave	R 13	V 10
K 550-25-5	concave	R 13	V 10
K 538-38-6	concave	R 13	V 10
K 550-50-5	concave	R 13	V 10
KS 960-38-9	concave	R 13	V 10
BK 538-38-5	gritted corundum	R 13	V 10
BQ 530-20-5	Sanded with quartz	R 12	V 10
G 538-38-5	polished	R 11	V 10
GES 538-38-5	closed gritted	R 12	
GES 538-38-5	chequerplate	R 10	
GRP-Safetytritt	gritted	R 13	

Test basis: information sheet ZH 1/571 for floors in workrooms and working areas with risk of slipping.

Test location: German Institute for Work Safety, St. Augustin.

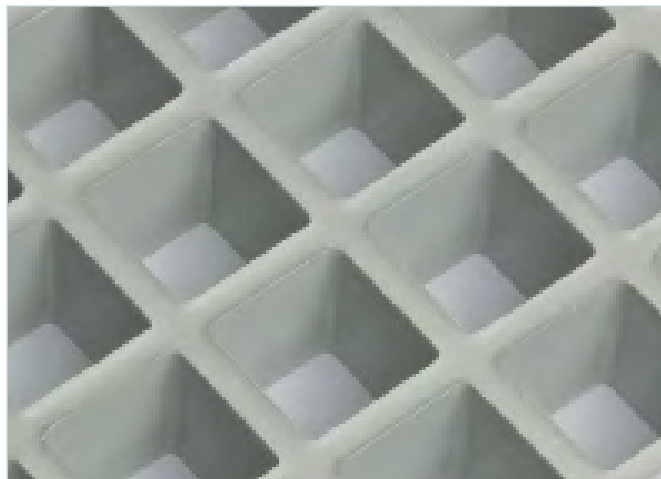

The concave surface is produced as part of the manufacturing process.

Quality class	
from 6° to 10°	R 9
more than 10° to 19°	R 10
more than 19° to 27°	R 11
more than 27° to 35°	R 12
more than 35°	R 13

We often get asked about the flammability of our GRP gratings. They are subjected to regular flammability tests at recognised testing institutions to guarantee quality remains consistent.

Lichtgitter standard isophthalic GRP-K gratings are classified as flame-retardant floor coverings Bfl-s1 in accordance with DIN EN 13501-1. We would be happy to provide you with copies of the test certificates on request.

- The test certificates contain the following findings, among others:
- The “flame front” takes more than 26 minutes to travel the 250 mm to the measuring point (see pictures). The longest burning length was just 260 mm after 30 minutes.
- After edge flaming (15 sec) according to DIN EN ISO 11925-2, the flames extinguished independently within 15 to 17 seconds.
- The visual impact of the smoke emissions was classified as “low”.
- No part of the grating fell off in flames.

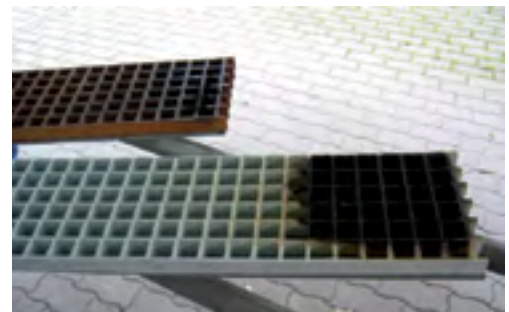

MPA NRW
Mittelprüfanstalt Nordrhein-Westfalen

Zuordnung der in den deutschen Baunormen verwendeten bauaufsichtlichen Bezeichnungen zu den neuen europäischen Klassifizierungen nach EN 13501-1 für Bodenbeläge

Bauaufsichtliche Bezeichnungen	Europäische Klasse nach DIN EN 13501-1
Nichtbrennbare Bodenbeläge	A1s
	A2s - s1
Schwerentflammbare Bodenbeläge	Bs - s1
	Cs - s1
Normalentflammbare Bodenbeläge	A2s - s2
	Bs - s2
	Cs - s2
	Ds - s1
Leichtentflammbare Bodenbeläge	Ds - s2
	Es
	Fs

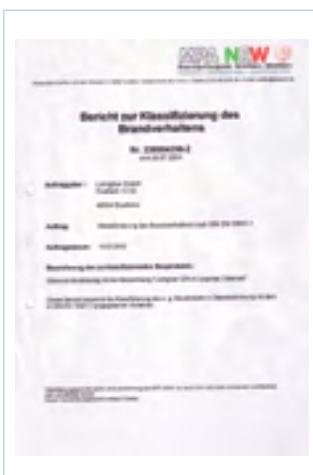

We supply all fixings for GRP gratings in galvanised steel, stainless steel Wst. 1.4301 and stainless steel Wst. 1.4571. The fixings for GRP gratings make it quick and easy to fit or remove them.

Employer's Liability Insurance Association regulations require each grating used in an area with a danger of collapse or falling to be fastened with positive locking at its four corners as a bare minimum.

For more information on fastening gratings, please refer to Arbeitsstätten-Verordnung § 12 – prevention of collapse and falling objects with reference to worksheet H 10 "Gratings in industrial construction" (page 5, section 5.2).

Individual gratings must be prevented from moving by all fixings with the exception of fixings B 43840T and B 23840T.

All fastening material is subject to a maintenance check and must be tested for effectiveness. The test intervals depend on the usage conditions. The operator must hand-screw the fixing if necessary. For this reason, the fixings are not covered by a legally binding warranty.

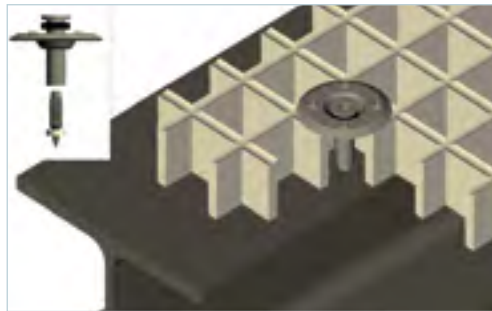

Cartridge-fired pin fixing B 438T
Composed of a spring cap with a firmly connected threaded sleeve and cartridge-fired pin.

This fixing is suitable for mesh spacings of ca. 25 to 40 mm.



Direct screw joint B 638T
Composed of spring cap, bolt, washer, nut M8 and plastic locking ring.

This fixing can be fitted from above in conjunction with a self-cutting screw (by the building contractor).

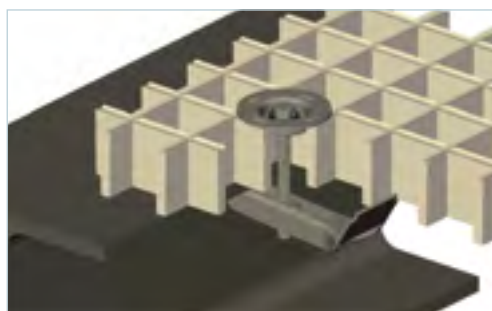

Standard fixing B 138T
Composed of spring cap, clamp base, bolt, nut M8 and plastic locking ring.

This fixing can be fitted from above in a pre-fabricated state for mesh spacings of 38 mm and above – screw lengths at least grating height plus 40 mm.

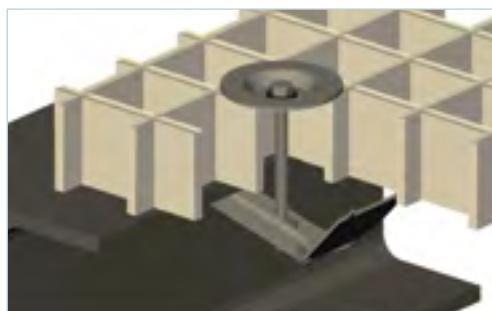

Standard fixing B 151T
Composed of spring cap, clamp base, bolt, nut M8 and plastic locking ring.

This fixing can be fitted from above in a pre-fabricated state for mesh spacings of 50 mm and above – screw lengths minimum grating height plus 40 mm.

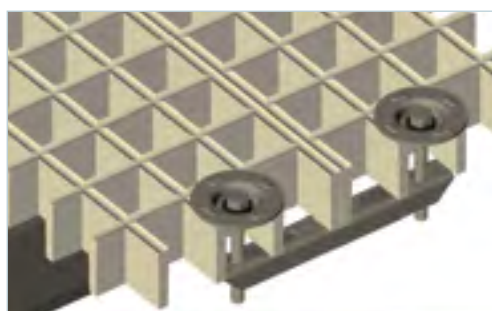

Double clamp fixing B 938T
Composed of spring caps, clamp base, bolts, nuts M8 and plastic locking ring.

The double clamp fixing connects neighbouring gratings to points susceptible to greater amounts of deflection. It prevents trip hazards and can be fitted from above - screw lengths at least grating height plus 30 mm.

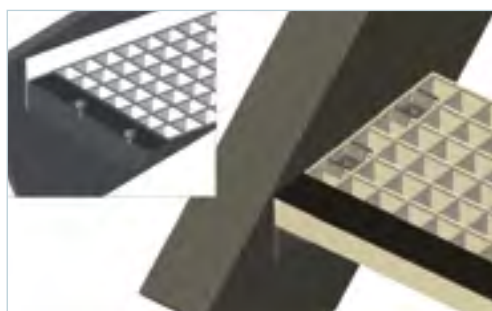

Stairtread fixing B 638K
Composed of clamp top, bolt, self-fastening nut M8 and washer.

The stairtread fixing connects stairtread gratings with the support brackets of the stair framework. Each stairtread grating is secured with 4 fixings.

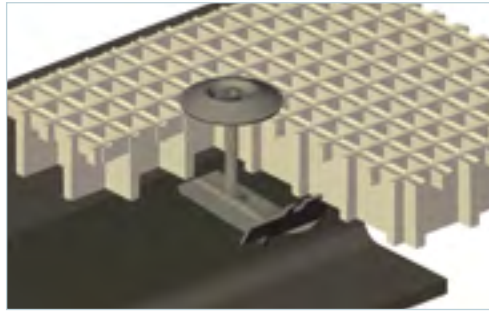

Standard fixing B 120TR
Composed of a special spring cap, clamp base, bolt, nut M8 and plastic locking ring.

This fixing was developed especially for close-mesh GRP gratings – screw lengths at least grating height plus 40 mm.

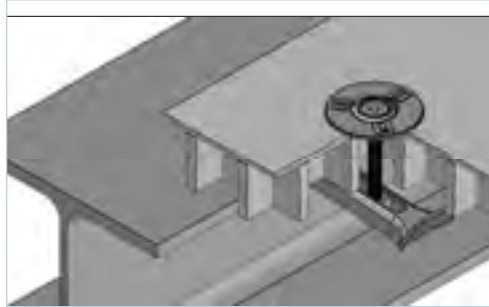

Standard fixing B 138TR
Composed of a special spring cap, clamp base, bolt, nut M8 and plastic locking ring.

This fixing was developed especially for close-mesh GRP gratings – screw lengths at least grating height plus 40 mm.

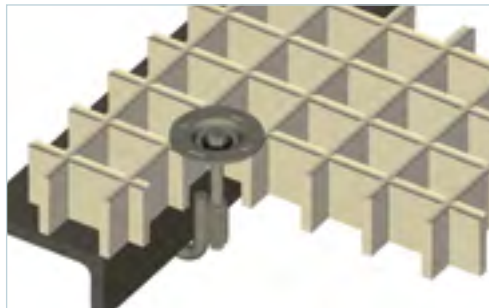

Hook bolt fixing B 738T
Composed of a spring cap, hook bolt fit to the substructure, bolt, nut M8 and plastic locking ring.

The bracket profile of the substructure must be specified. This fixing can be fitted from above.

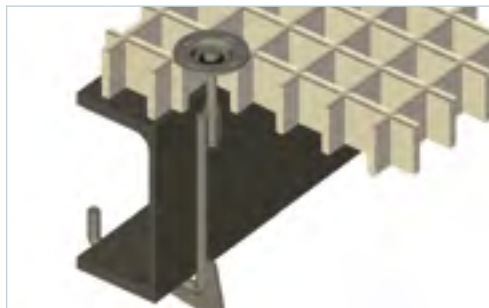

Hook bolt fixing B 838T
Composed of a spring cap, hook bolt fit to the substructure, bolt, nut M8 and plastic locking ring.

The U-profile of the substructure must be specified. This fixing can be fitted from above.



Note
We can also supply the fixings with clamp tops.

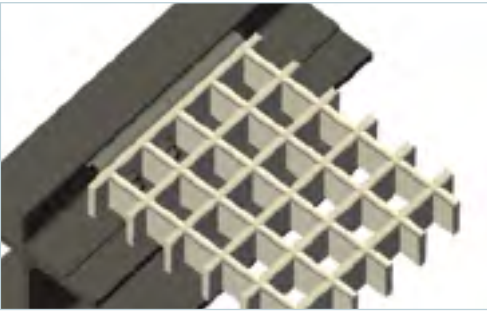

Hinge B 1680
Composed of:

- 2 hinge plates
- 1 hinge pin
- 2 U-washers
- 2 cotter pins

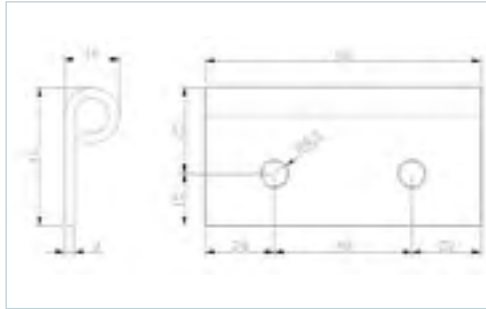

Hinges can be supplied in galvanised steel, stainless steel Wst. V2A and stainless steel Wst. V4A



Lifting handle B 8.115
Composed of:

- Handle XB 115
- 2 spring caps
- 2 nuts M8

The lifting handle can also be used for solid GRP gratings.



Lifting handles can be supplied in galvanised steel, stainless steel Wst. V2A and stainless steel Wst. V4A.



Sealing kit
Composed of:

- 1 litre single-component seal paint
- 1 paint roller
- 1 lambskin roller
- 1 scraper

Our UV and weather resistant height-adjustable polypropylene plastic mounts have distinct advantages and can be used in walkways. Height-adjustable plastic mounts can be used in a variety of different situations and are a cost-effective substructure variant. We offer both "Easy" Lichtgitter positioning mounts and "Comfort" Lichtgitter positioning mounts. "Comfort" positioning mounts can be adjusted up to an angle of 5%, making it possible to have a completely level surface on a gradient.

The major advantages:

- low priced substructure
- quick assembly
- easily dismantled
- very resistant
- UV and weather resistant
- Height can be controlled to the millimetre
- Reinforced strands provide high load capacities
- Rounded edges to prevent damaging the subsurface

Base of the stilt mount:

- Area: approx. 314 cm²
- Strength: 5 mm
- Diameter: approx. 200 mm

Top of the stilt mount

- Area: approx. 227 cm²
- Strength: 4 mm
- Diameter: approx. 150 mm

We would be glad to provide assembly instructions on request.

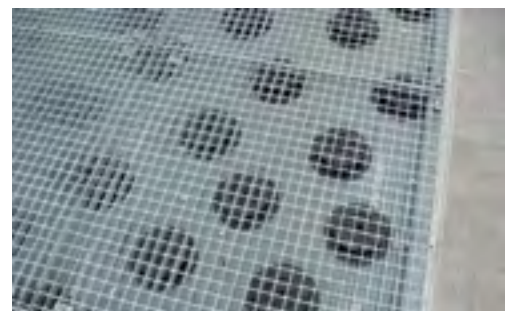

“Easy” positioning mounts

Model code	Height	Adjustment
LGB-02	28 mm	to 40 mm
LGB-2	40 mm	to 55 mm
LGB-3	55 mm	to 85 mm
LGB-4	85 mm	to 140 mm
LGB-5	116 mm	to 200 mm
LGB-6	198 mm	to 230 mm
LGB-7	224 mm	to 365 mm
LGB-8	342 mm	to 455 mm
LGB-9	452 mm	to 620 mm
LGB-10	562 mm	to 790 mm
LGB-11	672 mm	to 995 mm
LGB-12	782 mm	to 1120 mm

Our height-adjustable plastic mounts are produced using an injection moulding procedure and consist of a base and a top. Additional spacers will be used for greater heights (see pictures of individual parts). The different individual parts can be individually screwed to each other and are suitable for outdoor as well as indoor use.

Gratings can be screwed onto height-adjustable plastic mounts with traditional

spring caps/clamp tops in conjunction with direct joints coupling, making assembly simple, quick and cost-effective.

Our height-adjustable plastic mounts are a cost-effective alternative to traditional substructures and are recognised for their flexible handling. Their large contact area keep surface pressure on the subsurface low. Rounded edges protect delicate base layers. The pp mounts can be placed directly on the subsurface. Mounted systems achieve good liquid/rain water drainage.

A slope correction (up to 5%) can be achieved by using a baseplate on which the pedestals can be used.

Attention: The load cases have to be considered linked to the height of the pedestals.



Base



Spacer



Top



Note

Our height-adjustable plastic mounts are not suitable for supporting machinery or equipment which may vibrate. They are also not suitable for areas open to traffic.

"Comfort" positioning mounts

Model code	Height	Adjustment
LGC-0	17 mm	none
LGC-1	28 mm	none
LGC-2	35 mm	to 53 mm
LGC-3	50 mm	to 78 mm
LGC-4	74 mm	to 110 mm
LGC-5	100 mm	to 170 mm
LGC-6	170 mm	to 290 mm
LGC-7	240 mm	to 400 mm
LGC-8	320 mm	to 520 mm
LGC-9	390 mm	to 620 mm

Our "Comfort" positioning mounts are also height-adjustable and can adjust their angle up to 5%. The combining of individual parts makes it possible to adjust the mount to the height you require. Direct joints can be used as fixings for the mounts.

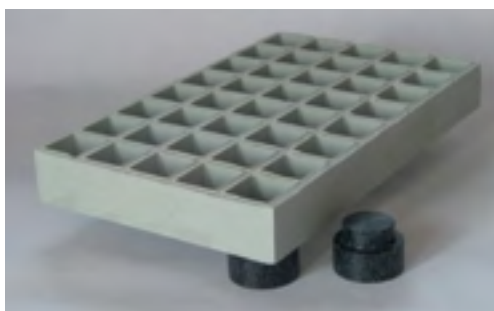
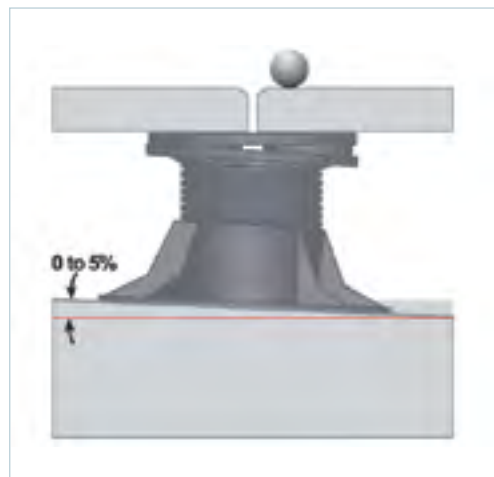

Individually produced PE mounts make lower haunch heights possible, ensuring that liquids/rain water will drain way.

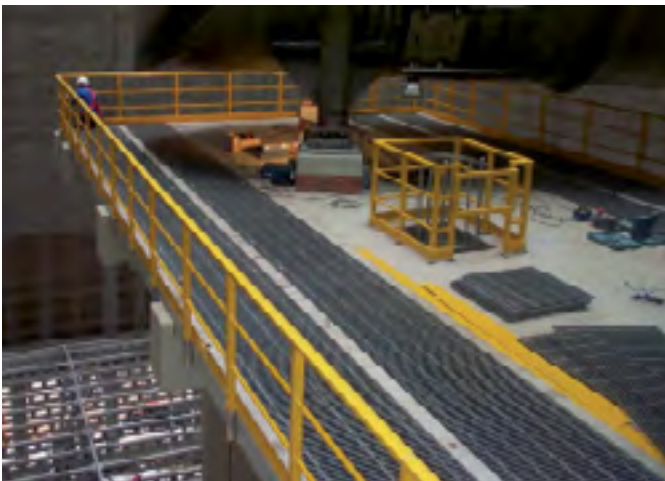

Top:
GRP handrails on a cooling tower

Middle:
GRP handrails to prevent falls

Bottom:
completely pre-assembled
GRP staircase





Top left:
Self-supporting GRP staircase

Bottom left:
Pre-assembled platform
crossing

Top right:
GRP structure

Bottom right:
Vertical ladder made entirely
of GRP





Top:
Detail of a possible GRP
structure

Middle:
Substructure in a sewage
treatment plant

Bottom:
Sewage treatment plant
covering

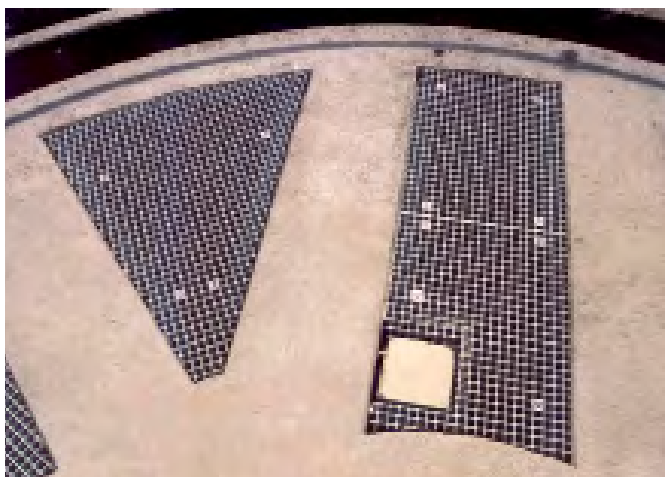



Top left:
Complete structure made
from GRP profiles

Bottom left:
Detail of a possible GRP struc-
ture

Top right:
Pre-assembled GRP staircase
with GRP joints

Bottom right:
Carport cladding



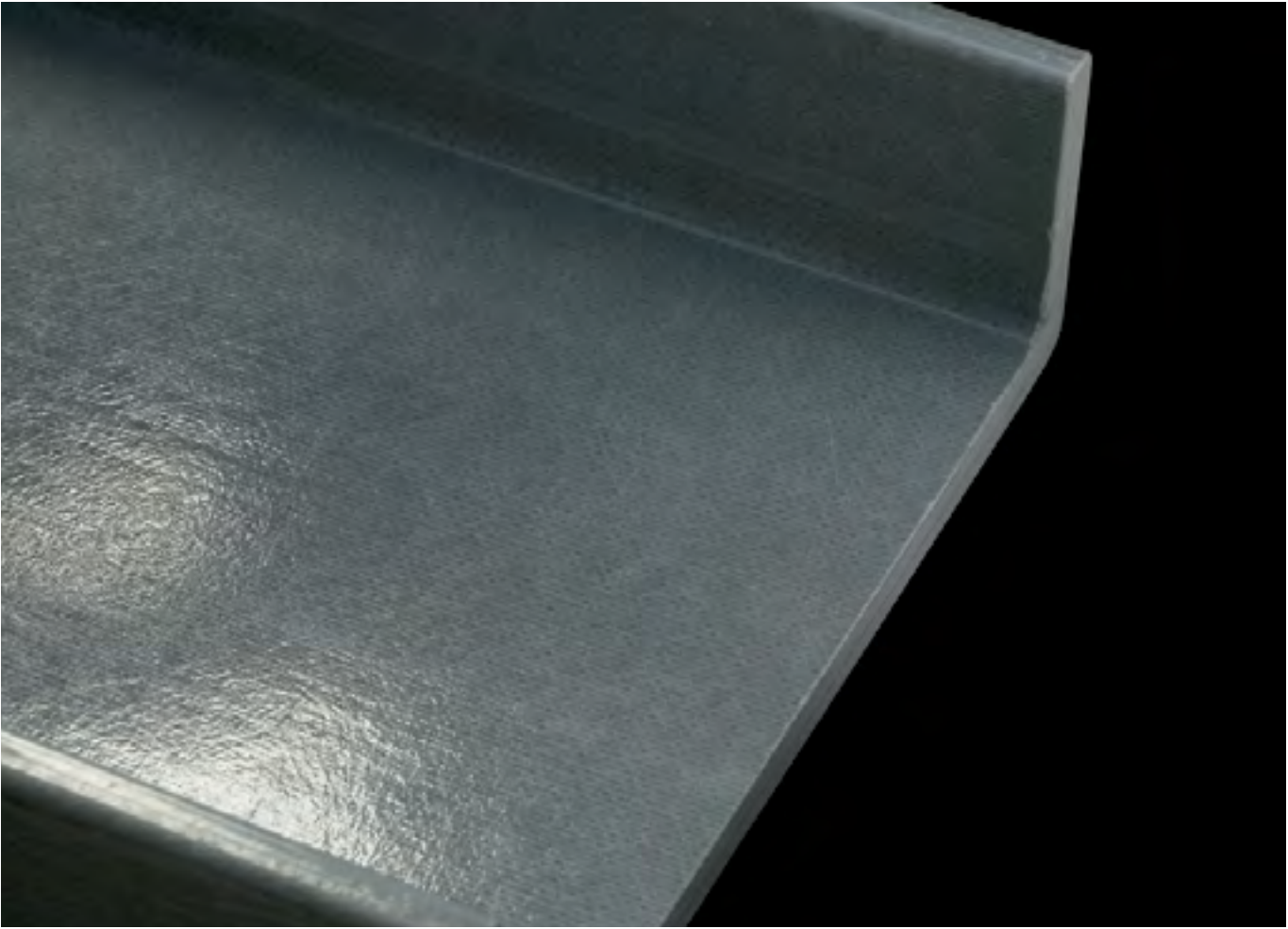

Profiles are produced by means of a pultrusion method. This method is distinguished by a continuous production procedure. The materials used are pulled into the pultrusion machine and shaped into the desired form. The materials are immersed in resin and are then passed through a tool until the final profile shape is achieved. Standard profiles are 6000 mm long.

Material characteristics

- High resistance to corrosion
- Suitable for use in corrosive environments
- Corrosion-resistant
- Low weight
- Easy to machine
- Can be supplied in a wide range of shapes and colours
- Low assembly costs
- No spark formation
- Heat and cold resistant
- Low transport costs

Range of applications

- Engineering
- Model making
- Food industry
- Bridge building
- Ship building
- Sport and leisure
- Environmental engineering
- Off-shore
- Tunnel construction
- Electrical industry
- Chemical industry
- Civil engineering
- Agriculture
- Plant construction
- Logistics and transportation
- Shipping



Required minimum characteristics for GRP construction profiles according to
DIN EN ISO 13706:2006-02

Characteristics	Unit	Standard	Minimum value according to EN 13706 model E 23
Test in original size	GPa	EN 13706-2	23
Elasticity module – longitudinal direction	GPa	EN ISO 527-4	23
Elasticity module – transverse direction	GPa	EN ISO 527-4	7
Tensile strength – longitudinal direction	MPa	EN ISO 527-4	240
Tensile strength – transverse direction	MPa	EN ISO 527-4	50
Anchor load bearing capacity - longitudinal direction	MPa	EN 13706-2	150
Anchor load bearing capacity - transverse direction	MPa	EN 13706-2	70
Flexural strength - longitudinal direction	MPa	EN ISO 14125	240
Flexural strength – transverse direction	MPa	EN ISO 14125	100
Interlaminary shear strength	MPa	EN ISO 14130	25

Other material characteristics for GRP construction profiles

Characteristics	Unit	Standard	Value
Pressure resistance – longitudinal direction	MPa	EN ISO 14126	220
Pressure resistance – transverse direction	MPa	EN ISO 14126	70
Specific weight	kg/dm ³	EN ISO 1183	1.7 – 2.0
Impact resistance	Barcol	ASTM D2583	50
Water absorption	%	ISO 62	0.4 – 0.7
Puncture resistance	kV/mm	DIN 53481	5 – 10
Surface resistance	OHM	ASTM D257	10 ¹²
Heat expansion coefficient	10 ⁻⁶ K ⁻¹	ASTM D696	11
Heat conductivity	W/(Km)	ASTM C177	0.35

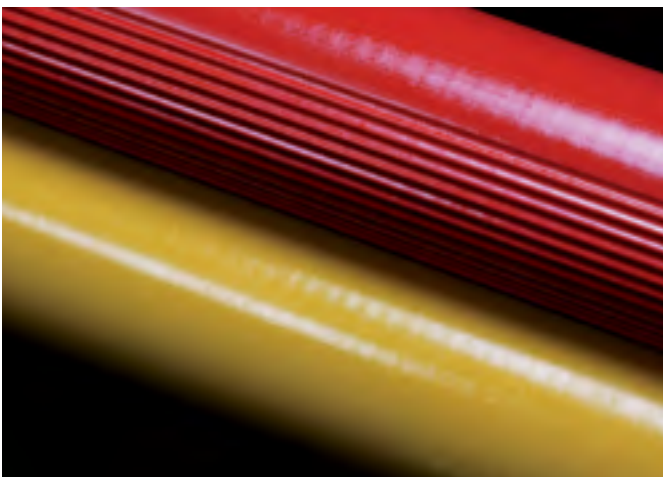

U profile model

U Profile (a; b; s1) mm	Weight kg/m	Dimension a mm	Dimension b mm	Dimension s1 mm
44.5 x 20 x 3.2	0.45	44.5	20	3.2
60 x 60 x 5	1.53	60	60	5
100 x 50 x 6	2.04	100	50	6
150 x 50 x 6	2.57	150	50	6
120 x 60 x 8	3.23	120	60	8
150 x 45 x 8	3.23	150	45	8
200 x 80 x 8	4.95	200	80	8
200 x 60 x 10	5.40	200	60	10
300 x 100 x 15	12.69	300	100	15

Other U-profiles available on request

I profile model

I Profile (a; b; s1) mm	Weight kg/m	Dimension a mm	Dimension b mm	Dimension s1 mm
150 x 75 x 6	3.11	150	75	6
100 x 50 x 8	2.65	100	50	8
120 x 60 x 8	3.22	120	60	8
150 x 75 x 8	4.09	150	75	8
200 x 100 x 10	6.84	200	100	10

Other I-profiles available on request

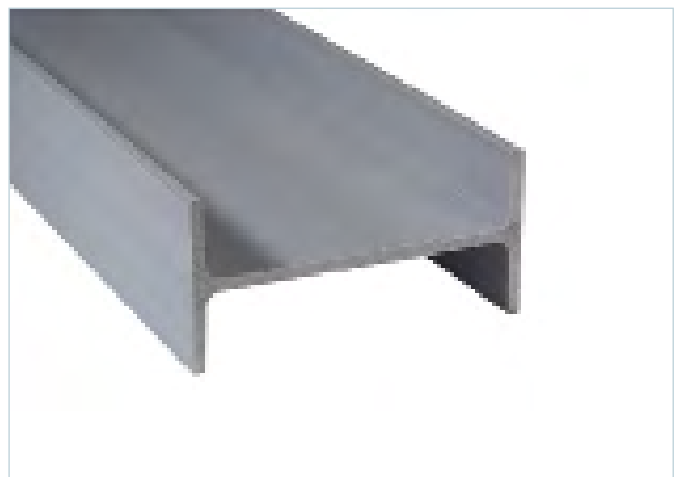
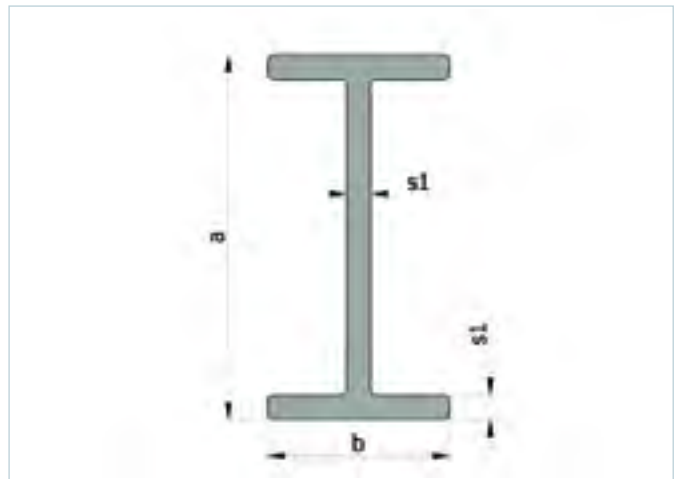
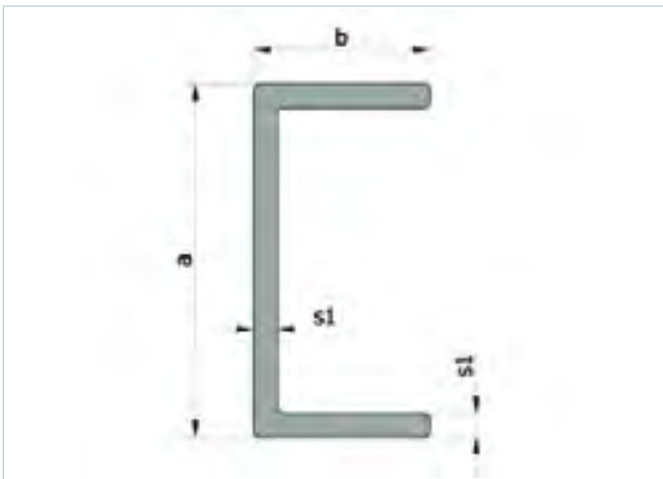

GRP angle model

GRP angle (a; b; s1) mm	Weight kg/m	Dimension a mm	Dimension b mm	Dimension s1 mm
50 x 50 x 3	0.53	50	50	3
30 x 30 x 5	0.50	30	30	5
35 x 35 x 5	0.59	35	35	5
45 x 45 x 5	0.77	45	45	5
50 x 50 x 5	0.89	50	50	5
60 x 60 x 5	1.04	60	60	5
60 x 60 x 8	1.63	60	60	8
75 x 50 x 8	1.69	75	50	8
100 x 100 x 8	2.76	100	100	8

Other GRP angles available on request

GRP square tubes

GRP square tubes (a; b; s1) mm	Weight kg/m	Dimension a mm	Dimension b mm	Dimension s1 mm
51 x 51 x 3.25	1.12	51	51	3.25
60 x 60 x 4.5	1.80	60	60	4.5
50 x 50 x 5	1.62	50	50	5
70 x 70 x 5	2.34	70	70	5
44 x 44 x 6	1.64	44	44	6
75 x 75 x 6	2.98	75	75	6
90 x 90 x 8	4.72	90	90	8

Other GRP square tubes/rectangular tubes available on request

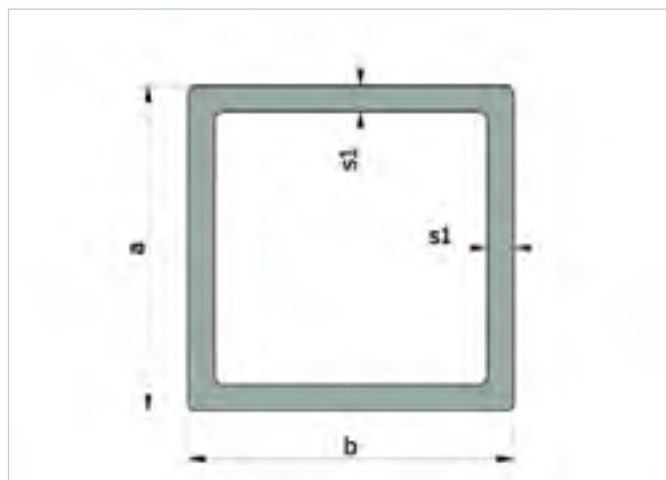
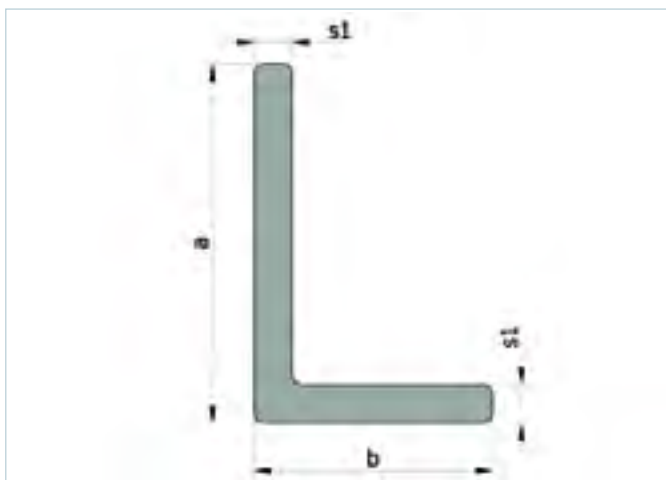

Lichtgitter GRP handrails are produced from GRP profiles reinforced with glass fibre. Their defining characteristic is their good resistance to corrosion. The ease of installation and on-site customisation also impress.

Our GRP standard handrails are composed of:

- Square tube posts: 60 x 60 x 4.5 mm
- Handrail: ergonomic
- Knee rail(s): tube 38 mm
- Toe plate: 150 mm high trapezoidal shaft profile

The post bases for GRP handrails can be attached to concrete, clips attached by the building contractor and substructure profiles. We would be happy to provide you with further details adapted to your construction plans.

We can provide post bases in various materials on request. The maximum distance between posts should be 1200 mm at a horizontal load of 500 N/m and 1500 mm at a horizontal load of 300 N/m.

The standard colours for the GRP profiles are signal yellow, similar to RAL 1003 or grey, similar to RAL 7001.

Lichtgitter GRP handrail profiles can be delivered as 6000 mm standard lengths. We can tailor the posts to the lengths you require and insert holes for the knee rail. We would be happy to deliver GRP handrails pre-assembled and provide assembly and working instructions. We can also provide assemblies and assembly assistance if needed.

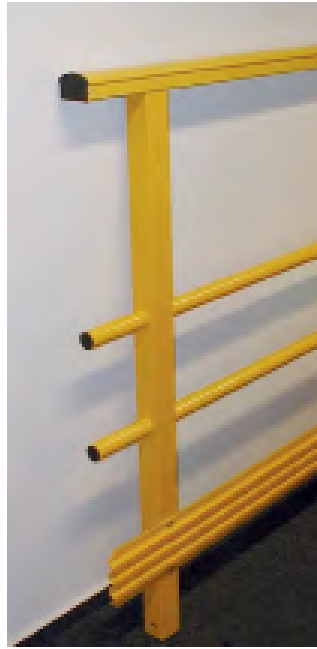

Some safety requirements for handrails in the vicinity of machinery are described below. The majority of the following design requirements for new fixed handrails near machinery are essentially stipulated in DIN EN ISO 14122-3.

- Service platforms and means of access to working areas such as staircases are to be secured with fixed handrails if the fall height exceeds 500 mm.
- The handrails must be at least 1100 mm high.
- If there is a distance of more than 200 mm between a service platform or staircase and a neighbouring wall or machine, a handrail must be installed. A toe plate is already required if the distance exceeds 30 mm.
- To avoid people falling through the gap beneath the handrail, it must have a knee rail or a similar protective structure. The clearance between the handrail and knee rail, the knee rail and the toe plate and between two knee rails if necessary may be no more than 500 mm.
- Toe plates should prevent people slipping under handrails or objects falling from the walkway onto working places or transportation routes below and endangering people. Toe plates must be at least 100 mm high. If there is a gap between the toe plate and walkway, this may measure a maximum of 10 mm.
- If there is a gap in the handrail, the gap between two handrail sections may be no smaller than 75 mm and no larger than 120 mm. If the gap is any larger, a self-closing barrier for the passageway should be used.

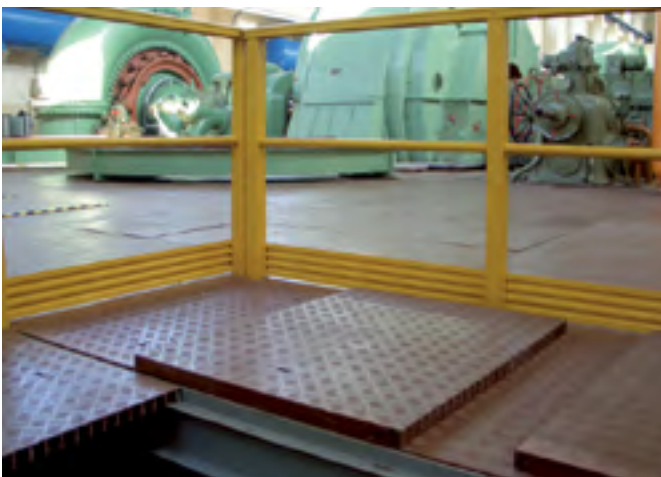

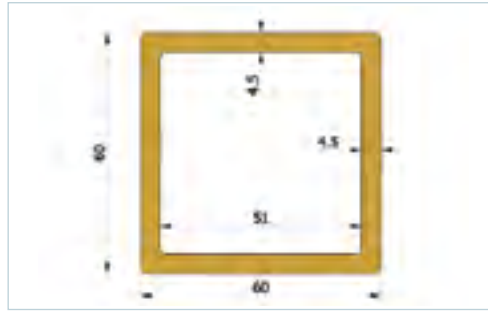
**Posts**

Dimensions: 60 x 60 mm
 Profile thickness: 4.5 mm
 Standard length: 6000 mm
 Colour: yellow or grey
 Weight: 1.24 kg/m

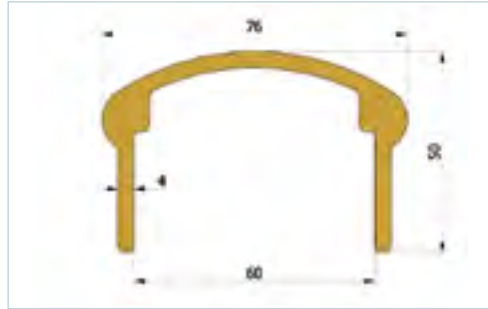
**Handrail**

Dimensions: 76 x 50 mm
 Profile thickness: 4 mm
 Standard length: 6000 mm
 Colour: yellow or grey
 Weight: 1.34 kg/m

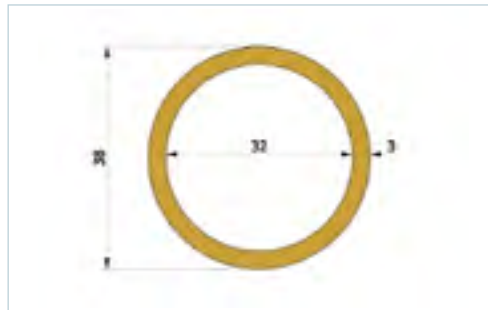
**Knee rail**

Dimensions: 38 mm
 Profile thickness: 3 mm
 Standard length: 6000 mm
 Colour: yellow or grey
 Weight: 1.16 kg/m

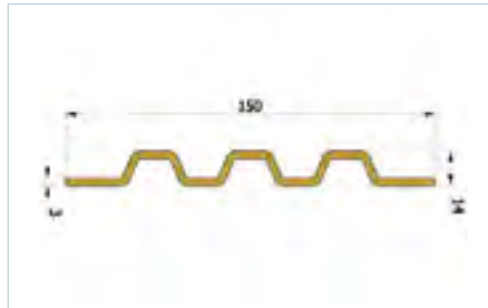
**Toe plate**

Dimensions: 150 x 14 mm
 Profile thickness: 3 mm
 Standard length: 6000 mm
 Colour: yellow or grey
 Weight: 1.38 kg/m



PE end caps for the handrail and knee rail are provided for a clean rail end.



GRP handrail bases are available in a variety of different materials

Left:
GRP handrail bases for attachment to level surfaces

Mid-left:
A range of connection possibilities show the different ways in which GRP handrails can be used

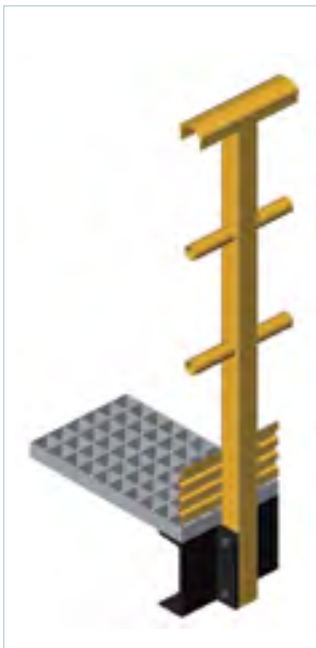

Lichtgitter GRP staircases
GRP staircases have many advantages over traditional staircase systems, from a low unladen weight and simple installation through to very high corrosion resistance as well as good thermal insulation. Our GRP staircase systems can be produced in a variety of different modulations (e.g. one-sided, double-sided handrails, platform, stairway crossing).

GRP staircases are produced in accordance with ISO 14122-3.

The stairs on GRP staircases provide excellent comfort and safety (quality class R 13) thanks to concave or sanded surfaces, especially in working areas with increased danger of slipping. They are also highly durable and UV resistant.

Some of the safety requirements for staircases in the vicinity of machinery are described below. The following design requirements for staircases near machinery are essentially stipulated in DIN EN ISO 14122-3 (see also page 32).

The tread g and pitch h must comply with the equation $600 \leq g + 2h \leq 660$ (dimensions in mm).

The undercut r of the stair must be ≥ 10 mm and must apply equally for landings and platforms.

A flight of stairs must, where possible, have a constant pitch.

The headroom must be at least 2300 mm.

Headroom c must measure at least 1900 mm.

Unless extraordinary circumstances make it impossible, the width of the staircase must be at least 600 mm and preferably 800 mm. If people are expected to pass each other on the staircase, the width must be extended to 1000 mm. If the staircase is used as an escape route, the width of the staircase must comply with special regulations.

The stair height of an individual staircase may not exceed 3000 mm. If it does, a platform is required before the next staircase. The platform must be at least 800 mm in length and must always be at least as large as the solid centre width of the stairs. If there is only one staircase, it may have a stair height of up to 4000 mm as an exception.

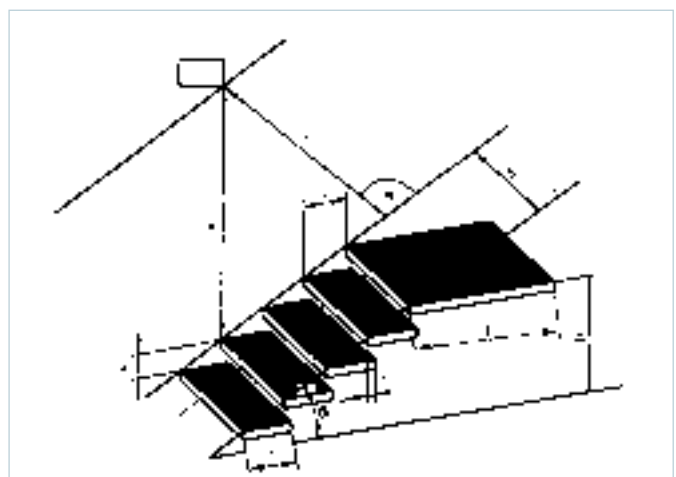
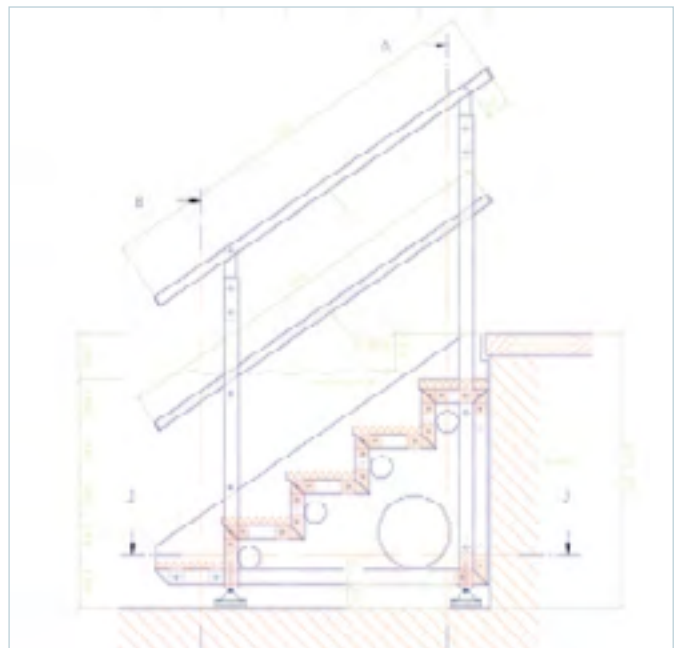



We would be glad to help you construct GRP stairs. A 3D representation can help you visualise it. We can also provide an auditable structural analysis on request.

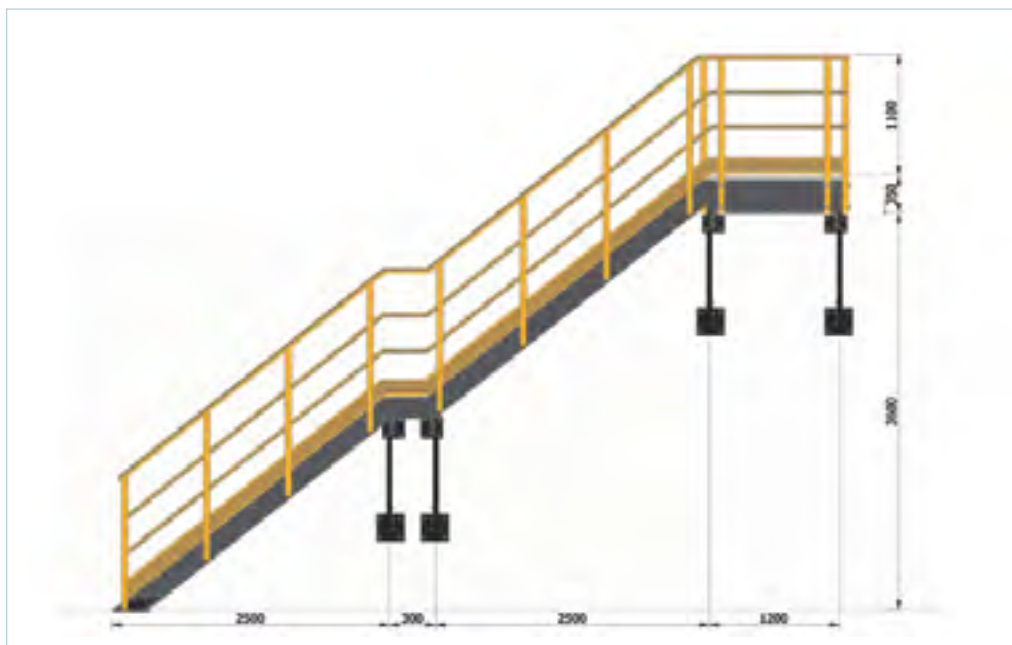

We design individually tailored GRP platforms and walkways. There is no limit to the variety of possible designs.



Lichtgitter GRP landings and walkways in use in the rail and manufacturing industry as well as waste treatment facilities. GRP solutions are particularly suitable for locations where corrosive elements are present or conductivity is an important factor.



Lichtgitter GRP vertical ladders are made of pultruded GRP profiles and are constructed to provide excellent protection in areas with high corrosion. Easily transportable parts and simple assembly are an excellent alternative to traditional vertical ladders. The special profile of the safety profiles used to construct the rungs provide optimum non-slip safety. The safety cage also provides additional safety.

GRP vertical ladders are suitable for both indoor and outdoor use. Our GRP ladders are produced in accordance with EN ISO 14122-4:2004 Safety of machinery – permanent means of access to machinery – part 4: fixed ladders.

Right and below:
GRP vertical ladders in industrial use.

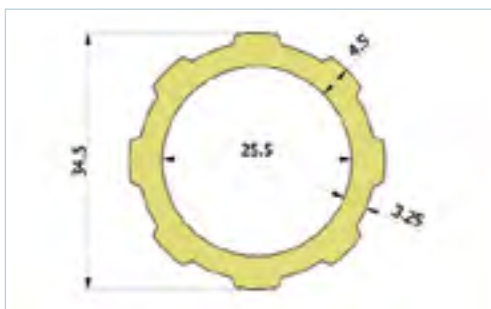

Non-slip rungs through profiling

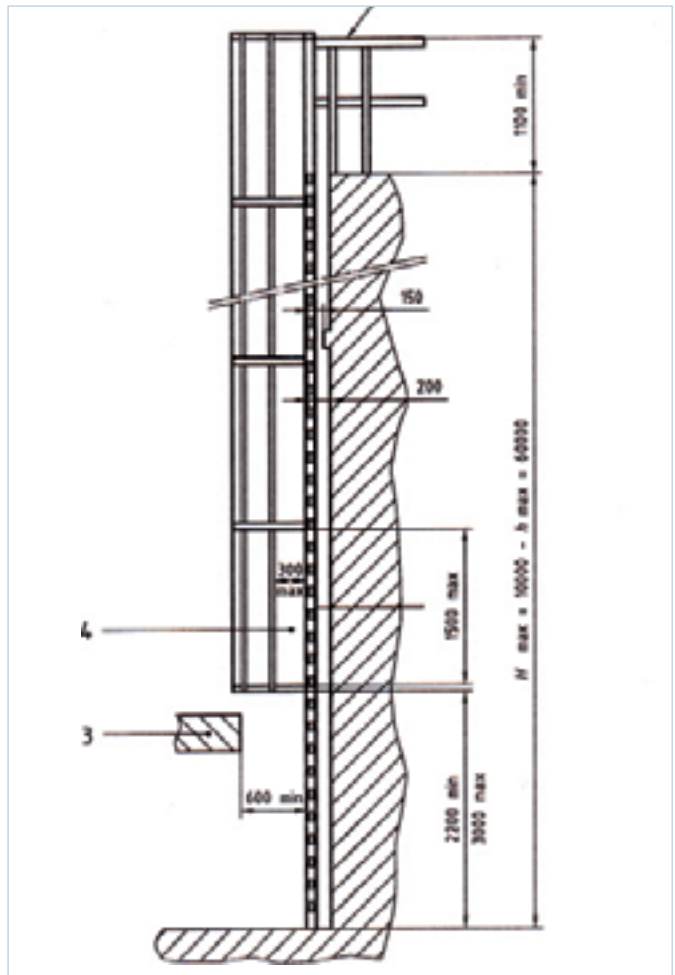

Lichtgitter GRP ladders can be produced in yellow and grey as standard. The advantages of GRP ladders become particularly obvious in areas with a chemically corrosive environment. If joints are provided, we will reinforce the square tubing with a PE inner core. The PE insert sockets prevent the rungs from rotating.

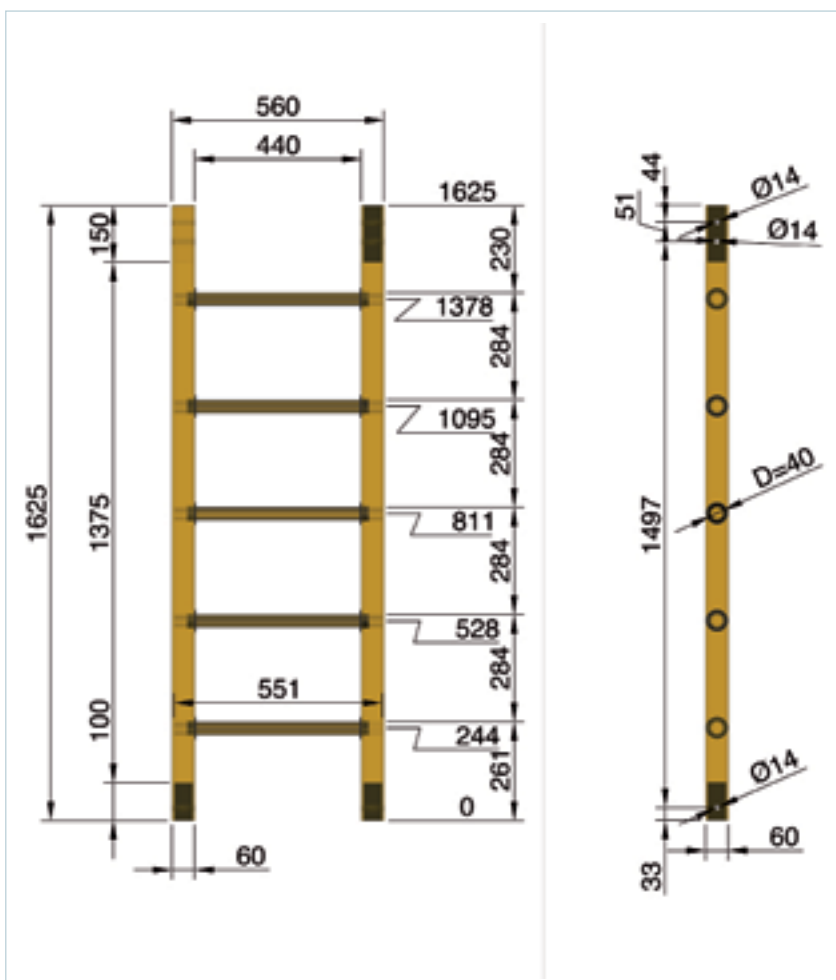
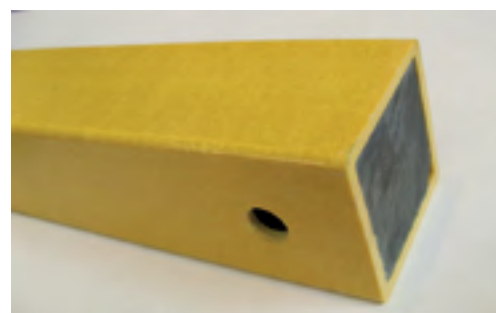

Lichtgitter GRP gratings are subject to fixed production and delivery tolerances. The tolerances for the grating heights and external dimensions comply with DIN 24537-3.

Length deviations and width deviations

B; L = max. + 0 mm to - 4 mm

Height deviations

H = max. + 1 / - 1 mm

Sections:

b; l = max. + 8 / - 0 mm

Diagonal deviation

Difference of measured diagonals D1 minus D2 max. $0.010 \times S$ (longest side length)

Evenness:

Deviation for convex in length and width: max. 8 mm

Deviation for concave in length and width: max 8 mm

Note

Single-sided closed GRP gratings may be subject to increased warping.

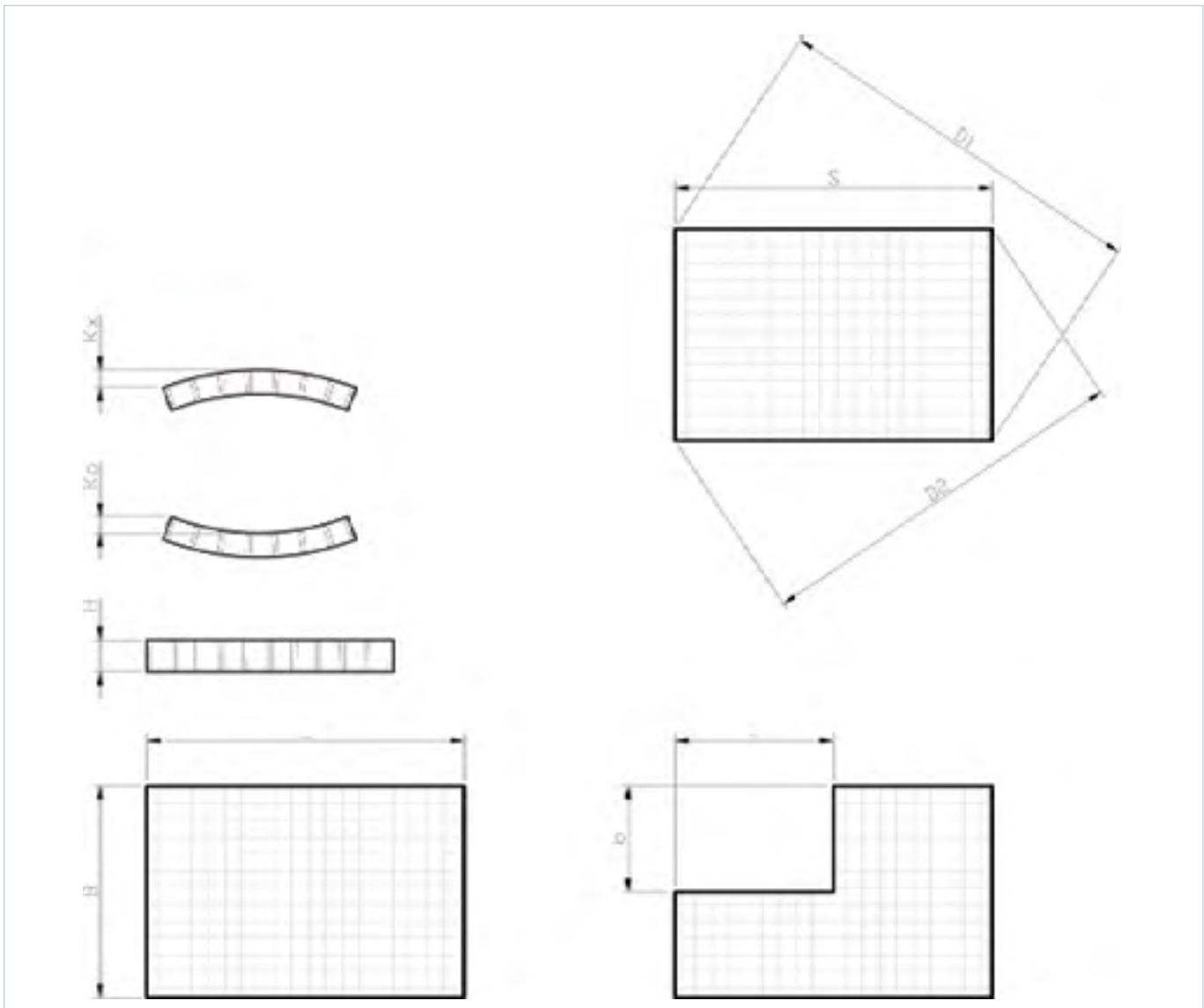

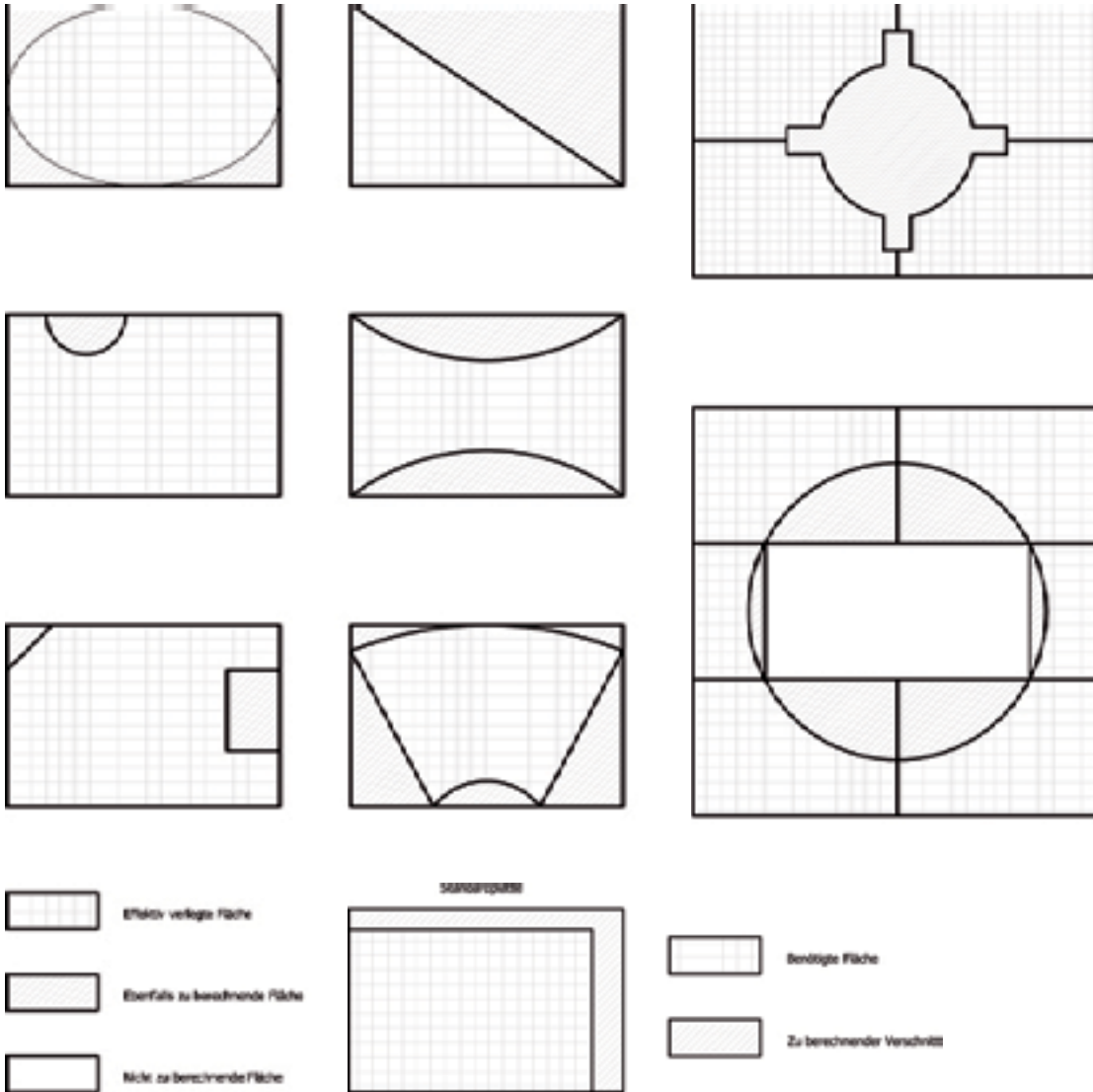

As described in work sheet H 10 produced by Arbeitsgemeinschaft Industriebau e.V. (AGI) et al., the complete rectangles including cuttings are used for dimensioning gratings (slightly modified for Lichtgitter GRP GmbH GRP gratings).

The area to be produced corresponding to the smallest rectangle or square which encompasses the grating is priced in square metres according to the smallest rectangle or square which encompasses the grating.

The dimensions of cut-outs and sections for openings, collar components and adjustments are calculated in the same way as the area to be produced of an individual grating.

Small individual cuts measuring up to 0.5 mm are priced at the unit price per metre with one premium per item if larger.

Additional services such as attaching toe plates, notches, nosings, non-standard surfaces, fixings, colouring GRP gratings etc. are priced at the unit prices agreed.

The lists of items (order confirmations), layout plans and/or the local survey form the basis for pricing.

Other special pricing procedures for GRP gratings
For our products made from sheet material, cuttings are priced per square metre and straight cuts per metre.

Wood machining tools and machinery are usually sufficient for the machining and processing of GRP gratings and profiles. Our many years of experience have however shown that using hard metal or diamond tools helps achieve a longer tool life.

As little dust as possible should be produced during machining in order to avoid medical irritations – for instance, people with sensitive skin may experience itching and a temporary rash. Good ventilation, dust extraction and using protective creams help prevent such irritations from occurring. We also recommend following basic safety guidelines such as wearing safety glasses and a mask.

Sawing

A regular hand saw or metal saw is sufficient for minor work. Squaring and mitring should be performed with a circular saw. You should use diamond tipped saw blades for a smooth and burr-free cut surface.

Sealing cut edges

The cut edges of GRP materials must be sealed after being sawn. This raises the risk of a loss of interlaminary stability due to moisture or other liquids permeating the material, leading to a decreased load capacity and the failure of the component.

The gratings and profiles are treated with a resin system or a single-component polyurethane coating, sealing the cut surfaces.

These handling guidelines are the result of years of experience machining and processing GRP products. They are accurate to the best of our knowledge but should not be considered strictly binding guidelines.

Safety information sheet in accordance with 91/155/EWG

Lichtgitter GRP GmbH & Co. KG
Product: Lichtgitter GRP gratings

1. Trade name:
Lichtgitter GRP gratings and profiles

Company: Lichtgitter GRP GmbH & Co. KG
Siemensstraße 1
D-48703 Stadtlohn

T + 49. 25 63. 911-203
F + 49. 25 63. 911-222

2. Compound/component information:
Glass-reinforced, high quality hardened resin

3. Possible dangers:
None known

4. First aid arrangements for dust accumulation:
In case of inhalation: find a supply of clean air and seek medical assistance if necessary.
In case of contact with eyes: open eyes wide and rinse with sufficient amounts of water; seek medical assistance if necessary

5. Fire-fighting measures:
Suitable extinguishing media: all (e.g. water, dry powder, foam, sand, CO₂, etc.) Unsuitable extinguishing medium for safety reasons: solid-stream water. Aluminium oxide, water and, depending on available oxygen and combustion temperature, carbon dioxide and carbon monoxide are to be expected as pyrolytic decomposition products.

6. Measures for unintended release:
N/a

7. Handling and storage:
No particular instructions, VbF class: none

8. Exposure controls and personal protection equipment
Provide good dust extraction during machining. Personal protection equipment: protective clothing, face mask and safety glasses if dust accumulates.

9. Physical and chemical characteristics
Form: solid
Colour: grey or as desired
Odour: slight styrol, if any
Density: approx. 1.8

10. Stability and reactivity
Hazardous reactions: if dust becomes hot during sawing and a significant amount accumulates in the machine, a fire may ensue in the machine if no heat supply is present.

Hazardous decomposition products: no decomposition if used appropriately.

11. Ecological information
Neutral in water

12. Disposal instructions
Can be disposed of in household waste, taking local official guidelines into consideration (waste code no. 120105A)

13. Transport information
Not a hazardous material according to national/international guidelines

14. Other information
This information is correct to the best of our knowledge and does not constitute a guarantee of characteristics. The recipients of our products are responsible for following existing legal legislation and regulations.



Lichtgitter GRP

Lichtgitter GRP GmbH &
Co. KG
Siemensstraße 1
D-48703 Stadtlohn

T +49. 25 63. 911-0
F +49. 25 63. 911-222

info@lichtgitter.de



Beteiligungen

Suomen Teräsritilä, Finnland
Le Caillebotis Diamond,
Frankreich
CSE Lichtgitter, Frankreich
Lichtgitter UK, Großbritannien
Las Pers, Niederlande
Lichtgitter Service Center
OTW, Österreich
Stegerud Steel, Schweden
Lichtgitter Anton Ruppli,
Schweiz
Lichtgitter Slovakia, Slowakei
Lichtgitter CZ, Tschechien
Lichtgitter Izgara, Türkei
Lichtgitter Bulgaria, Bulgarien

Lichtgitter Romania,
Rumenien
Qatar Gratings and Road
Barriers, Qatar

Vertretungen

Dänemark
Griechenland
Indonesien
Italien
Malaysia
Norwegen
Polen
Singapur
Spanien

www.lichtgitter.de

Stammwerk Stadtlohn

Lichtgitter Gesellschaft mbH
Siemensstraße 1
D-48703 Stadtlohn

Werk Sulz

Lichtgitter Gesellschaft mbH
Bahnhofstraße 76
D-72172 Sulz Neckar

Werk Blumberg

Lichtgitter Gesellschaft mbH
Schönower Straße 6
D-16306 Casekow-Blumberg